



**NORTH · WEST**



# PRICELIST

---

# 2023

---

- MODULAR SWITCHES
- FINAL DISTRIBUTION PRODUCTS
- SAFETY DEVICES

Effective July 2023

# HAPPY SWITCHING

Contemporary architecture and interiors have resulted in a need to adapt to the new age technology and design. We have developed quality products which are designed for different people, different needs, spaces and lifestyles. Aesthetically appealing yet functional, our products would surely add charm to your interiors.

**Happy Switching !**





**NORTH · WEST**

**ARTISA**  
*elegance redefined*

Page no. 04 to 11

**ARTISA**  
FLAT  
*elegance redefined*

*stylus<sup>+</sup>*  
dual mounting  
mechanism

Page no. 12 to 15

**convex**  
perma-fit assembly

Page no. 16 to 21

**NOWA**  
designed for you

Page no. 22 to 25

**venia**  
THE SLEEK PERFORMER

Page no. 26 to 29

**FIANZA**  
MINIATURE CIRCUIT BREAKER

Page no. 31

**AVANCÉE**  
FINAL DISTRIBUTION BOARDS

Page no. 32



**ARTISA**  
*elegance redefined*

**ARTISA**  
FLAT  
*elegance redefined*



New-age Designs

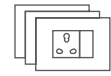

Wide Range



Safe Operations



**ANTIBACTERIAL**  
TOUCH POINTS



## ELEGANCE CRAFTED FOR CONTEMPORARY DECOR

ARTISA and ARTISA Flat, a premium range of switches; simplicity with elegance redefined with exquisite finishes that add a touch of style to your interiors.

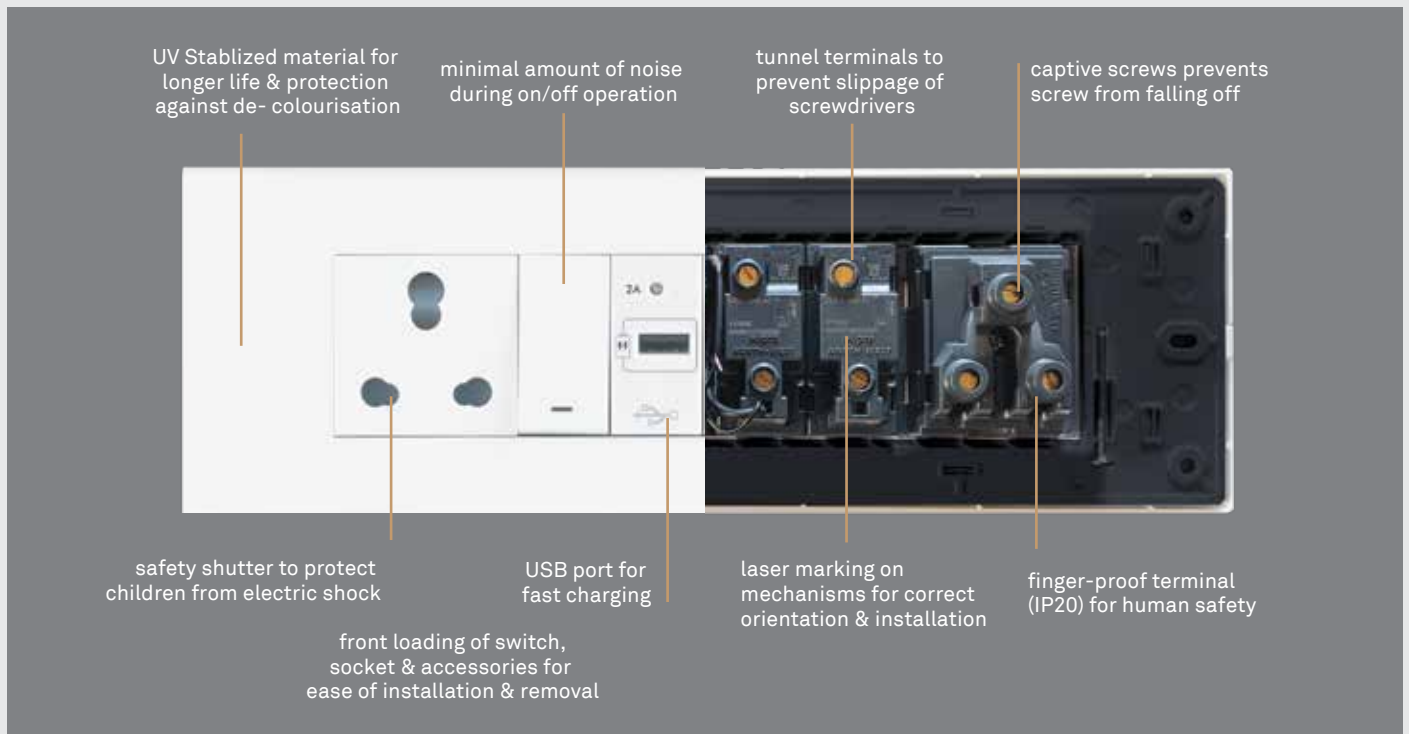

### new age design



Artisa Flat

Artisa

Premium flat and non-flat/rocker modular switch options in the same plate

### anti-bacterial touch points



\*Applicable on touch points like switch, bell push, fan regulator/dimmer & TT in white colour only.

### safe and sturdy

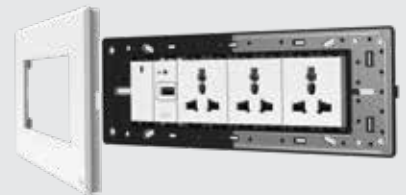

Careful implementation of extra sturdiness where required with inclusion of metal insert in 8 module horizontal plate.

## ARTISA SWITCHES

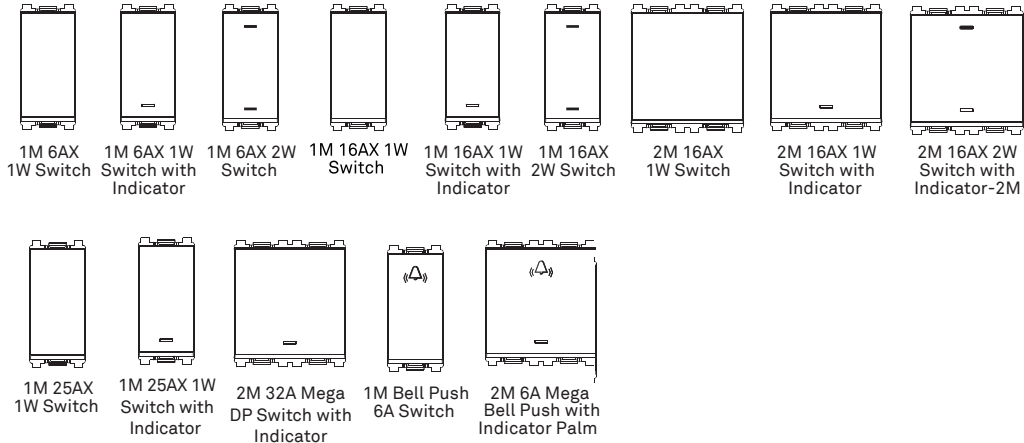

## ARTISA FLAT SWITCHES

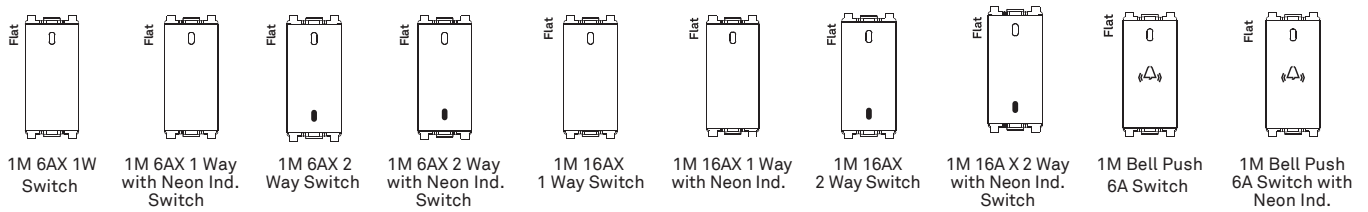

## SOCKETS

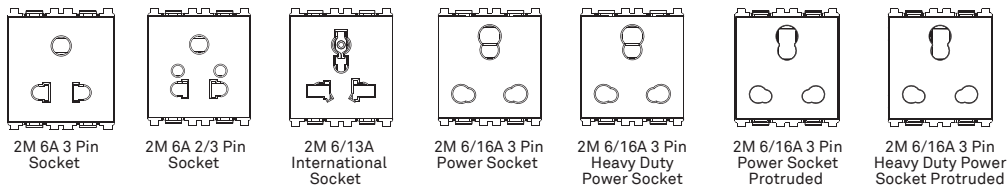

## FAN REGULATORS | DIMMERS

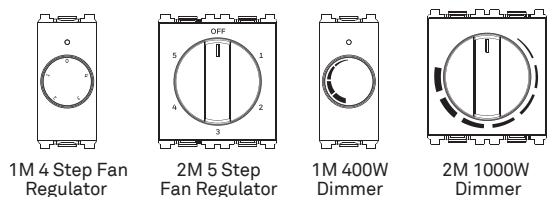



<b>ARTISA SWITCH/SOCKET/ACCESSORIES</b>					
<b>Cat No.</b>	<b>Material Description</b>	<b>Module Size</b>	<b>White MRP</b>	<b>Silver Grey/ Galaxy Black MRP</b>	<b>Inner/Outer Case Lot</b>
<b>SWITCHES</b>					
R0110	6A 1 Way Switch	1M	195	240	10/400
R0111	6A 1 Way Switch with Indicator	1M	300	355	10/400
R0210	6A 2 Way Switch	1M	275	340	10/200
R0130	16A 1 Way Switch	1M	325	395	10/400
R0131	16A 1 Way Switch with Indicator	1M	395	440	10/400
R0230	16A 2 Way Switch	1M	395	465	10/200
R0132	16A 1 Way Mega Switch	2M	410	480	10/200
R0133	16A 1 Way Mega Switch with Indicator	2M	470	565	10/200
R0233	16A 2 Way Mega Switch with Indicator	2M	540	645	10/200
R0150	25A 1 Way Switch	1M	425	520	10/400
R0151	25A 1 Way Switch with Indicator	1M	500	590	10/400
R0171	32A DP Switch with Indicator	2M	1145	1240	8/160
R0310	6A Bell Push Switch	1M	290	350	10/200
R0311	6A Bell Push Switch with Indicator	1M	370	465	10/200
R0341	6A Mega Bell push with Indicator Palm	2M	445	550	10/200
<b>FLAT SWITCHES</b>					
RF110	6A 1 Way Switch Artisa Flat	1M	275	340	10/400
RF111	6A 1 Way Switch with Neon Indicator Artisa Flat	1M	420	490	10/400
RF210	6A 2 Way Switch Artisa Flat	1M	375	475	10/400
RF211	6A 2 Way Switch with Neon Indicator Artisa Flat	1M	470	565	10/400
RF130	16A 1 Way Switch Artisa Flat	1M	430	490	10/400
RF131	16A 1 Way Switch with Neon Indicator Artisa Flat	1M	570	645	10/400
RF230	16A 2 Way Switch Artisa Flat	1M	595	650	10/200
RF231	16A 2 Way Switch with Neon Indicator Artisa Flat	1M	715	750	10/200
RF161	20A 1 Way Switch with Neon Indicator Artisa Flat	1M	595	645	10/200
RF310	6A Switch Bell Push Artisa Flat	1M	505	530	10/200
RF311	6A Switch Bell Push with Neon Indicator Artisa Flat	1M	610	640	10/200
<b>SOCKETS</b>					
R1212	6A 3 Pin Socket	2M	355	410	10/200
R1410	6A 2/3 Pin Socket	2M	380	450	10/200
R1532	13A Universal Socket	2M	470	585	10/200
R1332	6-16A Socket	2M	475	595	10/200
R1352	6-16A Heavy Duty Socket	2M	555	680	10/200
R1332P	6-16A Socket Power Protruded	2M	490	605	8/160
R1352P	6-16A Heavy Duty Power Protruded	2M	570	700	8/160
<b>FAN REGULATORS &amp; DIMMERS</b>					
R1700	4 Step Fan Regulator	1M	810	975	10/200
R1920	5 Step Fan Regulator	2M	1235	1465	5/100
R1500	400W Dimmer	1M	1100	1315	10/200
R2700	1000W Dimmer	2M	1425	1775	5/100



## COMMUNICATION | HOSPITALITY | SAFETY DEVICES

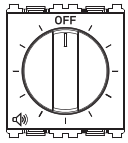

2M Volume Controller

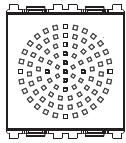

2M Buzzer

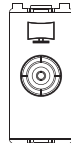

1M TV Co-Axial Socket

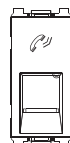

1M RJ 11 Tel. Socket

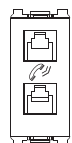

1M RJ 11 Tel. Twin Socket

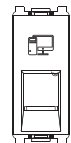

1M RJ 45 Cat 5e

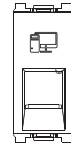

1M RJ 45 Cat 6



1M USB Charger 2A

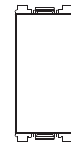

1M Indicator Lamp LED

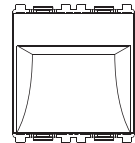

2M LED Night Lamp (Foot Light)

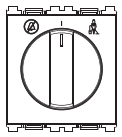

2M DND-CMR Internal Indicator

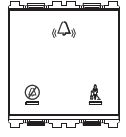

2M DND-CMR External Indicator

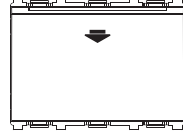

3M 30A Electronic Key Tag

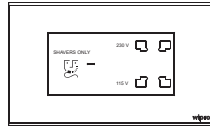

4M Shaver Socket

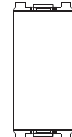

1M Blank Plate

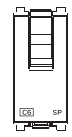

1M 6A/10A/16A/20A/25A/32A SP Tiny Trip

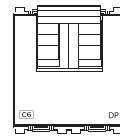

2M 6A/10A/16A/20A/25A/32A DP Tiny Trip



1M USB Type C PD Charger 18W



1M USB Type C Charger - 3A

## PLATES

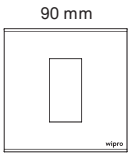

1 Module Plate

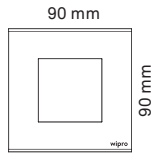

2 Module Plate

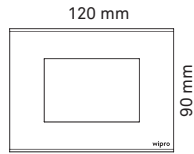

3 Module Plate

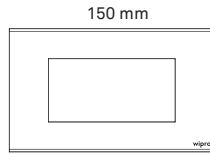

4 Module Plate

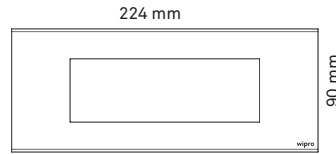

6 Module Plate

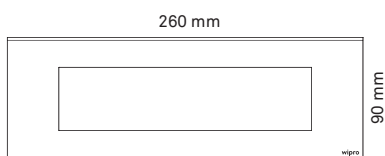

8 Module Horizontal Plate

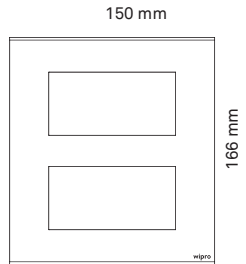

8 Module Plate Square

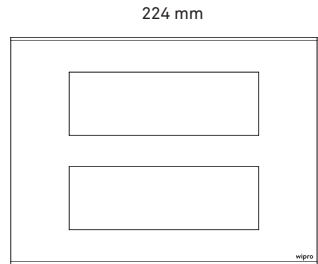

12 Module Plate

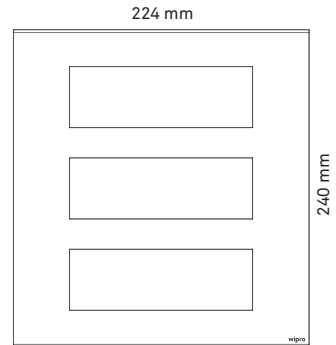

18 Module Plate

## COLOUR PLATES



SILVER GREY



MATT BLACK



CHAMPAGNE GOLD



GALAXY BLACK





**ARTISA ACCESSORIES**

Cat No.	Material Description	Module Size	White MRP	Silver Grey MRP	Inner/Outer Case Lot
<b>HOSPITALITY</b>					
R4300	Volume Controller	2M	1300	1350	5/100
R4401	Buzzer	2M	1135	1360	5/100
R4797	TV Co - Axial	1M	280	325	10/200
R4900	RJ 11 Telephone Socket Single Shutter	1M	270	315	10/200
R4700	RJ 11 Telephone Socket Double Shutter	1M	425	495	10/200
R5100	RJ 45 Computer Socket Cat5	1M	710	775	10/200
R5200	RJ 45 Computer Socket Cat6	1M	1165	1215	10/200
R4921	2A USB Charger	1M	2210	2420	5/100
R4600	LED Indicator Lamp	1M	345	410	10/200
RFL922	LED Night Lamp (Foot Light)	2M	845	960	6/120
R4604	DND-CMR Internal Indicator	2M	645	675	5/100
R4605	DND-CMR External Indicator	2M	350	360	5/100
R5500	30A Electronic Key Tag	3M	4460	4950	2/20
R5501	20A Electronic Key Tag	3M	3725	4510	2/20
R1542	Shaver Socket	4M	5110	5155	1/10
R3900	Blanking Plate	1M	65	90	20/400
R4931	3A USB Type C Charger	1M	2910	3430	5/100
R4932	3A TypeC Fast Charger	1M	4220	4975	5/100

**SAFETY DEVICES**

6A - 32A Single Pole Tiny Trip	1M	490	580	10/100
6A - 32A Double Pole Tiny Trip	2M	1020	1215	4/80

**ARTISA PLATES**

Cat No.	Material Description	Module Size	White MRP	Silver Grey/Matt Black/Champagne Gold MRP	Inner/Outer Case Lot
RP911	1 Module Plate	1M	220	365	10/240
RP922	2 Module Plate	2M	240	395	10/240
RP933	3 Module Plate	3M	275	440	10/240
RP944	4 Module Plate	4M	290	480	10/100
RP956	6 Module Plate	6M	510	840	5/120
RP966	6 Mod Plate with Met Frame	6M	585	1000	5/120
RP968H	8 Module Horizontal Plate	8MH	630	1095	5/120
RP968	8 Module Square Plate	8MS	750	1250	5/50
RP9712S	12 Module Plate	12M	905	1510	5/50
RP9718S	18 Module Plate	18M	1050	1760	5/30

**BACK GRID FRAME FOR DESIGN FINISH**

Cat No.	Material Description	Module Size	MRP	Inner/Outer Case Lot
RB911BACKF	1 Module Back Grid Frame	1M	150	10/240
RB922BACKF	2 Module Back Grid Frame	2M	165	10/240
RB933BACKF	3 Module Back Grid Frame	3M	185	10/240
RB944BACKF	4 Module Back Grid Frame	4M	190	10/100
RB956BACKF	6 Module Back Grid Frame	6M	325	5/120
RB966BACKF	6 Mod Met Back Grid Frame	6M	450	5/120
RB968HBACKF	8 Module Horizontal Back Grid Frame	8MH	485	5/120
RB968SBACKF	8 Module Square Back Grid Frame	8MS	495	5/50
RB9712BACKF	12 Module Back Grid Frame	12M	595	5/50

**ARTISA**  
*elegance redefined*

**ARTISA**  
— FLAT —  
*elegance redefined*

**DESIGNER COVER PLATES**

GLASS PLATES



AQUA GREEN



FROZEN MATT



DAPPER BLACK

WOOD PLATES



NATURAL TEAK



CHERRY MAHOGANY

METAL PLATES



RETRO BRONZE



ABSTRACT SILVER



**MATERIAL - GLASS**

	Aqua Green		Frozen Matt		Dapper Black	
	Cat Code	MRP	Cat Code	MRP	Cat Code	MRP
1 M Plate	RD911GLAAG	1170	RD911GLAFM	1640	RD911GLADB	1170
2 M Plate	RD922GLAAG	1180	RD922GLAFM	1655	RD922GLADB	1180
3 M Plate	RD933GLAAG	1240	RD933GLAFM	1690	RD933GLADB	1240
4 M Plate	RD944GLAAG	1430	RD944GLAFM	1895	RD944GLADB	1430
6 M Plate	RD956GLAAG	1500	RD956GLAFM	2040	RD956GLADB	1500
8 M Hor Plate	RD968HGLAAG	1570	RD968HGLAFM	2330	RD968HGLADB	1570
8 M Sq Plate	RD968SGLAAG	1920	RD968SGLAFM	2585	RD968SGLADB	1920
12 M Plate	RD9712GLAAG	2490	RD9712GLAFM	3365	RD9712GLADB	2490

**MATERIAL - METAL**

	Abstract Silver		Retro Bronze	
	Cat Code	MRP	Cat Code	MRP
1 M Plate	RD911METAS	2250	RD911METRB	2250
2 M Plate	RD922METAS	2300	RD922METRB	2300
3 M Plate	RD933METAS	2450	RD933METRB	2450
4 M Plate	RD944METAS	2750	RD944METRB	2750
6 M Plate	RD956METAS	3250	RD956METRB	3250
8 M Hor Plate	RD968HMETAS	3450	RD968HMETRB	3450
8 M Sq Plate	RD968SMETAS	6000	RD968SMETRB	6000
12 M Plate	RD9712METAS	7500	RD9712METRB	7500

**MATERIAL - WOOD**

	Natural Teak		Cherry Mahogany	
	Cat Code	MRP	Cat Code	MRP
1 M Plate	RD911WOONT	1500	RD911WOOCM	1500
2 M Plate	RD922WOONT	1585	RD922WOOCM	1585
3 M Plate	RD933WOONT	1980	RD933WOOCM	1980
4 M Plate	RD944WOONT	2210	RD944WOOCM	2210
6 M Plate	RD956WOONT	3235	RD956WOOCM	3235
8 M Hor Plate	RD968HWOONT	3800	RD968HWOOCM	3800
8 M Sq Plate	RD968SWOONT	4585	RD968SWOOCM	4585
12 M Plate	RD9712WOONT	6215	RD9712WOOCM	6215

**BACK GRID FRAME**



*stylus+*  
dual mounting  
mechanism

Contemporary collarless design  
Protective spark shield  
Terminals shrouding for greater protection





## **DOUBLE FITMENT FOR ENHANCED SAFETY**

Stylus+ comes with the benefit of dual fitment mechanism, which facilitates by holding all the modules firmly onto the base frame. This system ensures extra safety for user. Designed with high finish and aesthetics, the Stylus+ range offers plates in Gloss, Matt White and Metal finish.

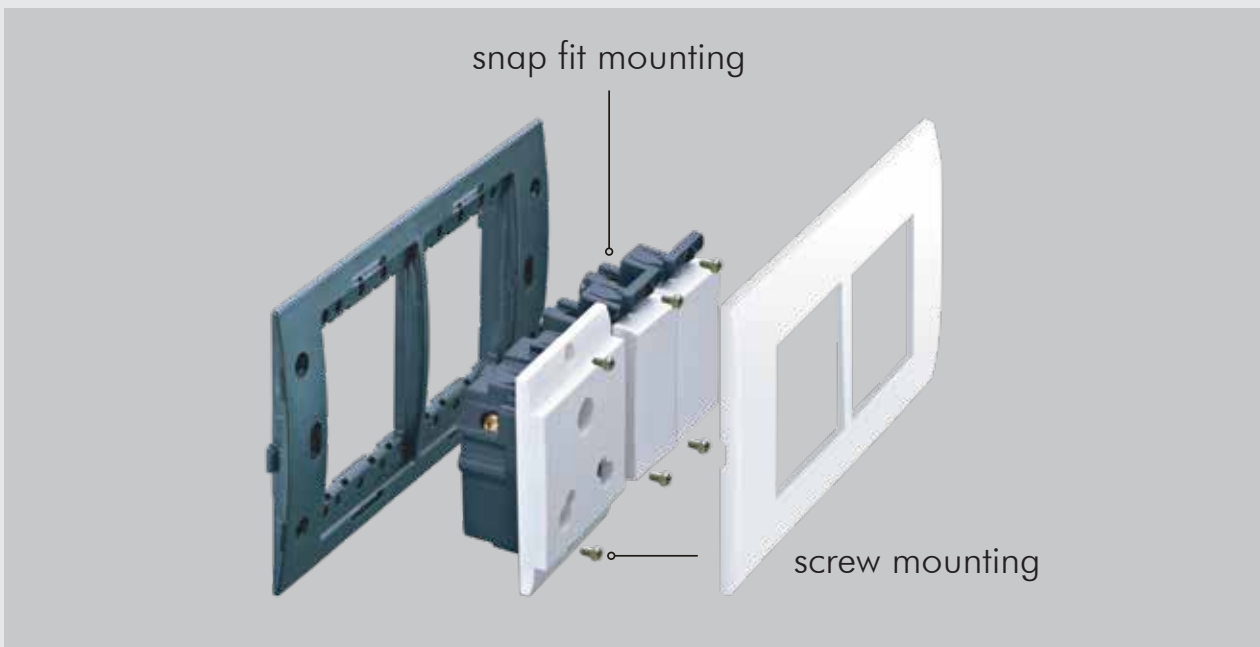

### **CLICK-ON MECHANISM**

Perfectly engineered click-on mechanism supports rapid installation



### **EASY TO USE**

Cover plates are designed with special notch on the side to aid fast and easy detachment



### **LOCATOR**

Two guiding points on the product act as guides and help in easy alignments

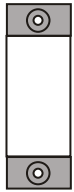

SR110  
SR130

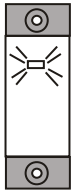

SR111  
SR131

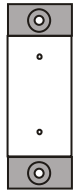

SR210  
SR230



SR211



SR310



SR311

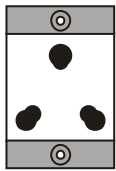

M1332  
M1352



M1532

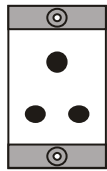

M1212

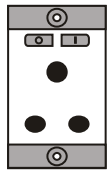

M3012

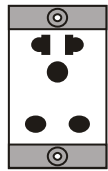

M1412

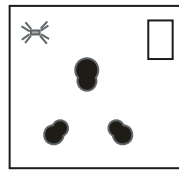

SR3033 16/6A

CS911M  
1 Module

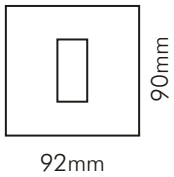

92mm

CS922M  
2 Module

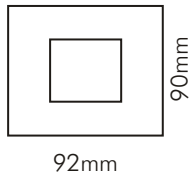

92mm

CS933MS  
3 Module

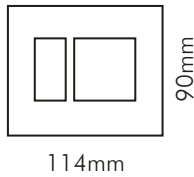

114mm

CS944M  
4 Module

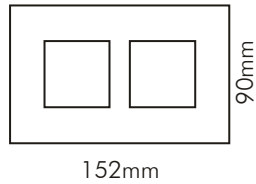

152mm

CS956M-S  
6 Module

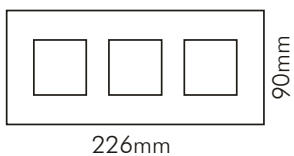

226mm

CS968M-H  
8 Module

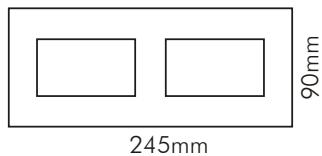

245mm

CS968M-S  
8 Module

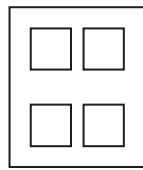

153mm

CS712MS  
12 Module

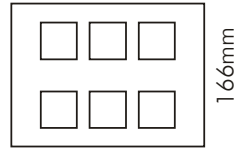

245mm

CS9718MS -18 Module

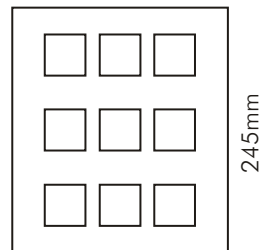

245mm

226mm



M1700

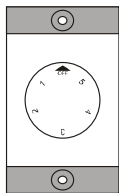

M1900

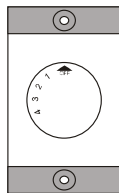

M1800

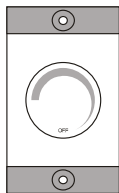

M2700



M1500

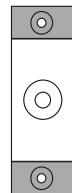

M4797

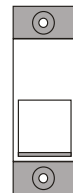

M4900S  
M5200  
SP45

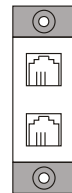

M4700



M3900

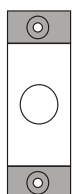

M4500



M4401



M4601



M4602

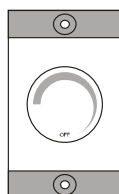

M4300

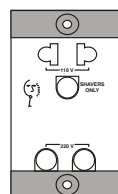

M1542



Cat No.	Module Size	Material Description	White/Euro White MRP	Silver Grey MRP	Inner/Outer Case Lot
<b>SWITCHES</b>					
SR110-PLUS	1M	Switch 6A One - Way - Plus	150	190	20/500
SR111-PLUS	1M	Switch 6A One - Way LED - Plus	220	275	20/500
SR130-PLUS	1M	Switch 16A One - Way - Plus	255	315	20/500
SR131-PLUS	1M	Switch 16A One - Way - Plus (with LED)	300	385	20/500
SR210-PLUS	1M	Switch 6A Two-way - Plus	210	260	20/500
SR211-PLUS	1M	Switch 6A Two-way LED -Plus	285	355	20/500
SR230-PLUS	1M	Switch 16A Two-Way - Plus	305	385	20/500
SR310-PLUS	1M	Bell Push 6A - Plus	230	290	20/500
SR311-PLUS	1M	Bell Push 6A LED - Plus	265	335	20/500
<b>SOCKETS</b>					
M1212-PLUS	2M	6A 2/3 Pin Socket - Plus	265	335	10/300
M1412-PLUS	2M	6A 2 and 3 Pin Socket - Plus	400	495	10/300
M1332-PLUS	2M	16/6A 6-Pin Power Socket - Plus	390	480	10/300
M1352-PLUS	2M	6/16A 6 Pin Heavy Duty Socket - Plus	470	600	10/300
M1532-PLUS	2M	International Socket 13/6 A - Plus	410	510	10/250
M3012-PLUS	2M	6A 3/2 Push button Integral Socket - Plus	470	590	10/250
SR3033	2M	16A Socket + Plate Combo	870	1080	1/-
<b>FAN REGULATORS AND DIMMERS</b>					
M1700-PLUS	1M	Fan Regulator 4 Position Steptype - Plus	675	965	10/400
M1900-PLUS	2M	Fan Regulator 6 Position with 360 rotation - Plus	915	1135	5/200
M1800-PLUS	2M	Fan Regulator 4 Position Step Type - Plus	825	1025	5/200
M1500-PLUS	1M	Dimmer 300 Watts - Plus	655	825	10/400
M2700-PLUS	2M	Dimmer 1000 Watts -Plus	1140	1425	1/120
<b>COMMUNICATION MODULES</b>					
M47970-PLUS	1M	Co-Axial T.V. Socket 1-Point -PLUS	205	250	20/600
M4900S-PLUS	1M	RJ11 Telephone Jack with shutter -PLUS	205	250	20/600
M47000-PLUS	1M	Twin RJ11 Telephone Outlet -PLUS	300	385	20/600
M51000-PLUS	1M	RJ 45 Cat 5 Socket with Shutter -PLUS	620	770	20/500
M52000-PLUS	1M	RJ 45 Cat 6 Socket with Shutter -PLUS	680	855	20/600
SP4500-PLUS	1M	Cover Plate for jack -PLUS	215	270	5/100
M49210-PLUS	1M	USB Charger 2A M&SR	1810	1935	5/100
<b>HOSPITALITY MODULES</b>					
M4401-PLUS	1M	Buzzer with Indicator 1M - Plus	550	680	10/300
M4601-PLUS	1M	1M Indicator (DND) - Plus	315	400	10/300
M4602-PLUS	1M	1M Indicator (CMR) - Plus	315	400	10/300
M1542-PLUS	2M	Shaver Socket 240V & 110V - Plus	885	1110	5/15
M4300	2M	Volume Control	740	925	5
SR5500	3M	Smart Card Key Tag - 25 A	2390	2990	1
FL921	2M	LED Foot Light	795	995	20
<b>SUPPORT MODULES</b>					
M3900-PLUS	1M	Blanking Plate - Plus	55	95	20/600
M4500-PLUS	1M	Telephone Cord Outlet - Plus	130	185	20/600
M4600-PLUS	1M	Indicator / Signal Lamp - Plus	135	200	20/600
<b>METAL PLATES</b>					
MP711MSB00	1M	1 Module Metallic SS-Brush Finish Plate	525		5
MP722MSB00	2M	2 Module Metallic SS-Brush Finish Plate	525		5
MP733MSB00	3M	3 Module Metallic SS-Brush Finish Plate	625		5
MP744MSB00	4M	4 Module Metallic SS-Brush Finish Plate	835		5
MP756MSBS0	6M	6 Module Metallic SS-Brush Finish Plate	1220		5
MP768MHSB0	8MH	8 Module Metallic SS-Brush Finish Plate	1425		5
MP768MSSB0	8MS	8 Module Metallic SS-Brush Finish Plate	1295		5
MP5712MSSB	12M	12 Module Metallic SS-Brush Finish Plate	2090		5
Cat No.	Module Size	Material Description	White/Euro White MRP	Silver Grey/ Matt Black MRP	Inner/Outer Case Lot
<b>COVER PLATES</b>					
CS911M-PLUS	1M	One Module Plate - Plus	155	255	10/240
CS922M-PLUS	2M	Two Module Plate - Plus	155	255	10/240
CS933MS-PLUS	3M	Three Module Plate - Plus	190	295	10/240
CS944M-PLUS	4M	Four Module Plate - Plus	205	325	5/200
CS956MS-PLUS	6M	Six Module Plate - Plus	330	515	8/120
CS968MH-PLUS	8MH	Eight Module Horizontal Plate - Plus	400	620	8/128
CS968MS-PLUS	8MS	Eight Module Vertical Plate - Plus	445	695	10/80
CS9712MS-PLUS	12M	Twelve Module Plate - Plus	535	830	10/20
CS9718MS-PLUS	18M	Eighteen Module Plate - Plus	740	1155	10/20

\*Silver Grey - Switches, accessories and plates

\*Matt Black - Plates



**convex**  
perma-fit assembly

Elegant collar design

Thermoset material for safe electrical insulation

Heavy metal contacts for better conductivity





## STURDY DESIGN WITH MORE PROTECTION

Convex is a perfect integration of classic design and modern technology. By combining superior electrical engineering technology with elegant aesthetics, it offers a wide range of metal plates, boxes and plastic enclosures for surface mounting.

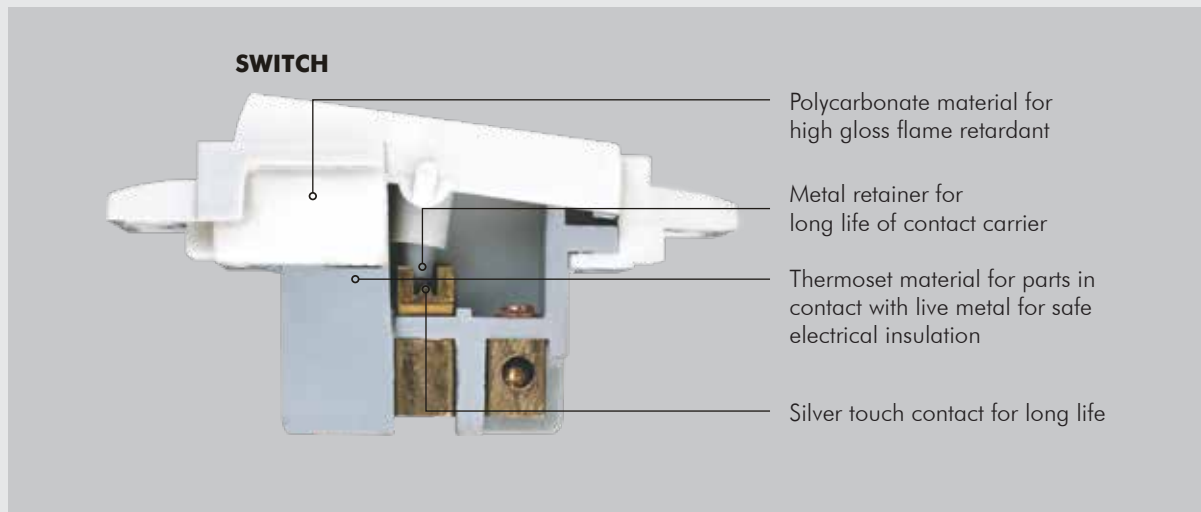



MO110  
MO130

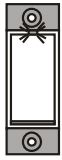

MO111  
MO131

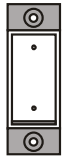

MO210  
MO230

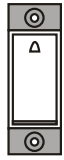

MO310



MO311

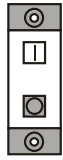

MO431  
MO451



MO440

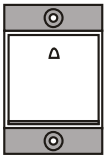

MO340



MO341



MO551



MO370

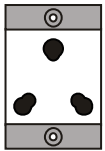

M1332  
M1352



M1532

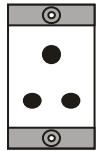

M1212

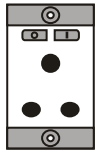

M3012

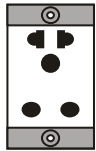

M1412

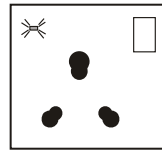

SR3033 16/6A

CS911M  
1 Module

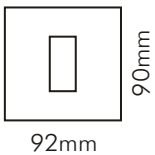

CS922M  
2 Module

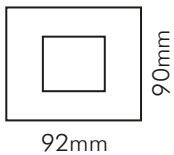

CS933MS  
3 Module

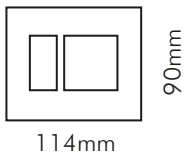

CS944M  
4 Module

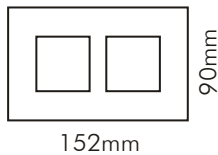

CS956M-S  
6 Module

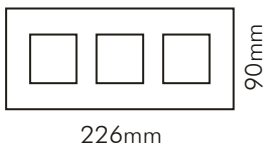

CS968M-H  
8 Module

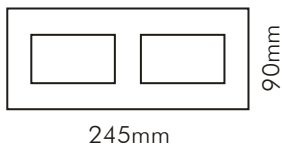

CS968M-S  
8 Module

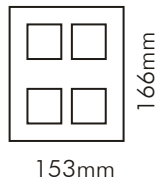

CS712MS  
12 Module

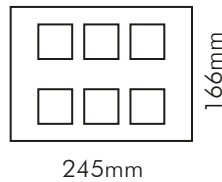

CS9718MS  
18 Module

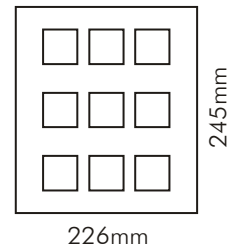



Cat No.	Module Size	Material Description	White/Euro White MRP (₹)	Silver Grey MRP (₹)	Inner/ Outer Case/Lot
<b>SWITCHES</b>					
M0110	1M	6A One Way Switch	140	180	20/600
M0111	1M	6A Oneway switch with Indicator	215	265	20/600
M0210	1M	6A Two Way switch	200	250	20/600
M0310	1M	Bell Push 6A	205	255	20/600
M0311	1M	Bell Push 1 Module with Indicator	260	330	20/600
M0340	2M	Palm Bell 6 A	255	320	20/300
M0341	2M	Palm Bell 6 A with Indicator	355	445	20/300
M0130	1M	16A One way switch	245	300	20/600
M0131	1M	16A One way switch with indicator	280	350	20/600
M0230	1M	16A Two way switch	280	350	20/600
M0431	1M	Switch Push Button 16 A with Indicator	335	425	10/300
M0451	1M	Switch Push Button 25 A with Indicator	415	530	10/300
M0440	2M	Palm Switch 16 A One way	315	405	10/300
M0551	2M	Palm DP One way 16 A with indicator	465	585	10/300
M0370	2M	Circular Bell switch 6A	420	530	5/200

<b>SOCKETS</b>					
M1212-PLUS	2M	6A 2/3 Pin Socket - Plus	265	325	10/300
M1412-PLUS	2M	6A 2 and 3 Pin Socket - Plus	400	480	10/300
M1332-PLUS	2M	16/6A 6-Pin Power Socket - Plus	390	465	10/300
M1352-PLUS	2M	6/16A 6 Pin Heavy Duty Socket - Plus	470	580	10/300
M1532-PLUS	2M	International Socket 13/6 A - Plus	410	495	10/250
M3012-PLUS	2M	6A 3/2 Push button Integral Socket - Plus	470	570	10/250
SR3033	2M	16A Socket + Plate Combo	870	1045	1/-

<b>METAL PLATES</b>					
MP711MSB00	1M	1 Module Metallic SS-Brush Finish Plate	505		5
MP722MSB00	2M	2 Module Metallic SS-Brush Finish Plate	505		5
MP733MSB00	3M	3 Module Metallic SS-Brush Finish Plate	605		5
MP744MSB00	4M	4 Module Metallic SS-Brush Finish Plate	810		5
MP756MSBS0	6M	6 Module Metallic SS-Brush Finish Plate	1180		5
MP768MHSB0	8M	8 Module Metallic SS-Brush Finish Plate	1380		5
MP768MSSB0	8M	8 Module Metallic SS-Brush Finish Plate	1380		5
MP5712MSSB	12M	12 Module Metallic SS-Brush Finish Plate	2025		5

Cat No.	Module Size	Material Description	White/Euro White MRP	Silver Grey/ Matt Black MRP	Inner/Outer Case Lot
<b>COVER PLATES</b>					
CS911M-PLUS	1M	One Module Plate - Plus	150	255	10/240
CS922M-PLUS	2M	Two Module Plate - Plus	150	255	10/240
CS933MS-PLUS	3M	Three Module Plate - Plus	180	295	10/240
CS944M-PLUS	4M	Four Module Plate - Plus	195	325	5/200
CS956MS-PLUS	6M	Six Module Plate - Plus	320	515	8/120
CS968MH-PLUS	8MH	Eight Module Horizontal Plate - Plus	385	620	8/128
CS968MS-PLUS	8MS	Eight Module Vertical Plate - Plus	430	695	10/80
CS9712MS-PLUS	12M	Twelve Module Plate - Plus	515	830	10/20
CS9718MS-PLUS	18M	Eighteen Module Plate - Plus	715	1155	10/20



M1700

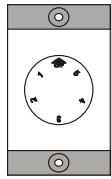

M1900

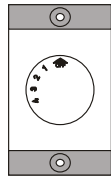

M1800

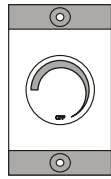

M2700



M1500

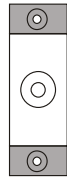

M4797

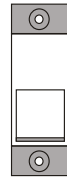

M4900S  
M5200  
SP45

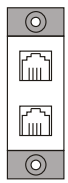

M4700

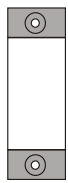

M3900

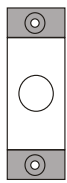

M4500

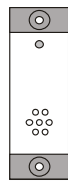

M4401



M4601



M4602

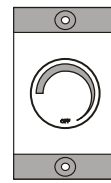

M4300

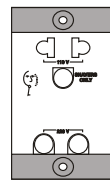

M1542

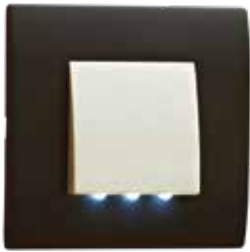

LED Footlamp



TINY TRIP



MOTOR STARTER



Cat No	Module Size	Description	White/Euro White MRP (₹)	Silver Grey MRP (₹)	Inner/Outer Case/Lot
--------	-------------	-------------	--------------------------	---------------------	----------------------

<b>FAN REGULATORS</b>					
M1700-PLUS	1M	Fan Regulator 4 Position Steptype - Plus	675	965	10/400
M1900-PLUS	2M	Fan Regulator 6 Position with 360 rotation - Plus	915	1135	5/200
M1800-PLUS	2M	Fan Regulator 4 Position Step Type - Plus	825	1025	5/200
M1500-PLUS	1M	Dimmer 300 Watts - Plus	655	825	10/400
M2700-PLUS	2M	Dimmer 1000 Watta - Plus	1140	1425	1/120

<b>COMMUNICATIONS MODULES</b>					
M47970-PLUS	1M	Co-Axial T.V. Socket 1-Point -PLUS	205	250	20/600
M4900S-PLUS	1M	RJ11 Telephone Jack with shutter -PLUS	205	250	20/600
M47000-PLUS	1M	Twin RJ11 Telephone Outlet -PLUS	300	385	20/600
M51000-PLUS	1M	RJ 45 Cat 5 Socket with Shutter -PLUS	620	770	20/500
M52000-PLUS	1M	RJ 45 Cat 6 Socket with Shutter -PLUS	680	855	20/600
SP4500-PLUS	1M	Cover Plate for jack -PLUS	215	270	5/100
M49210-PLUS	1M	USB Charger 2A M&SR	1810	1935	5/100

<b>HOSPITALITY MODULES</b>					
M4401-PLUS	1M	Buzzer with Indicator 1M - Plus	550	680	10/300
M4601-PLUS	1M	1M Indicator (DND) - Plus	315	400	110/300
M4602-PLUS	1M	1M Indicator (CMR) - Plus	315	400	10/300
M1542-PLUS	2M	Shaver Socket 240V & 110V - Plus	885	1110	5/150
M4300	2M	Volume Control	740	925	5
SR5500	3M	Smart Card Key Tag - 25 A	2390	2990	1
FL921	2M	LED Foot Light	795	995	20

<b>SUPPORT MODULES</b>					
M3900-PLUS	1M	Blanking Plate - Plus	55	95	20/600
M4500-PLUS	1M	Telephone Cord Outlet - Plus	130	185	20/600
M4600-PLUS	1M	Indicator / Signal Lamp - Plus	135	200	20/600

<b>TINY TRIP</b>				
Rating (Amp)	Single Pole MRP (₹)	Case Lot (Nos.)	Double Pole MRP (₹)	Case Lot (Nos.)
6A -32A	299	48	699	24

<b>SINGLE PHASE MOTOR STARTERS</b>				
Cat No.	Rating	Description	MRP (₹)	Inner Case Lot (nos.)
C 12M01 H	11.00 A - 18.00 A	2 Ton AC	425	20
C 12M01 J	16.00 A - 25.00 A	2.5 Ton AC	470	20

\*Silver Grey - Switches, accessories and plates

\*Matt Black - Plates



**NOWA**  
designed for you

Slim and Contemporary Design  
Pristine White with High Gloss  
Trustworthiness & Reliability of Wipro







## INNOVATIVE . SAFE . RELIABLE

North-West believes in delivering solutions that enables a satisfactory and safe use of their switches. The development of NOWA mapped all the common user requirements and translated them as distinctive features to offer more benefits and added value to its users.

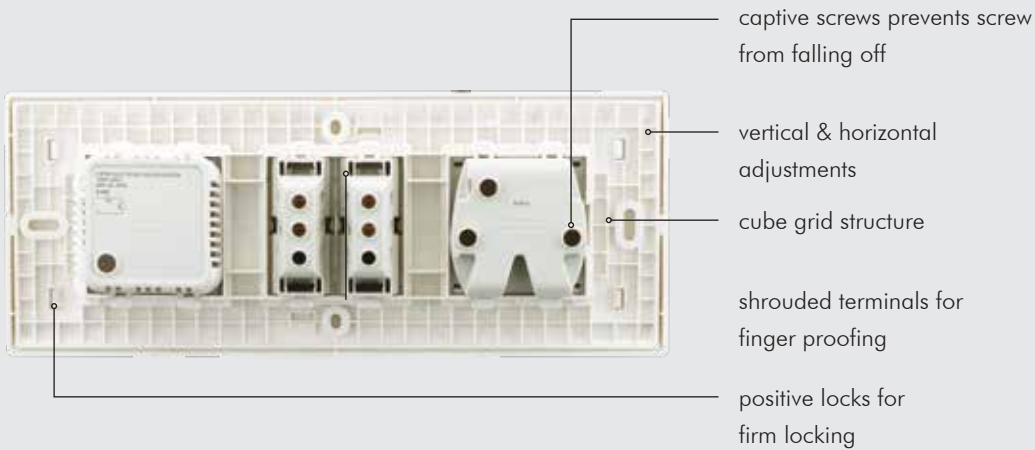

Slim and sleek, NOWA measures just 6.5mm



Wide ribs for hassle-free, non-obstructive switch and plug top operation



Slim socket back leaves more space for wire movement and reduces pressure on module



Spark shield to arrest the spark within the switch, safeguarding the user

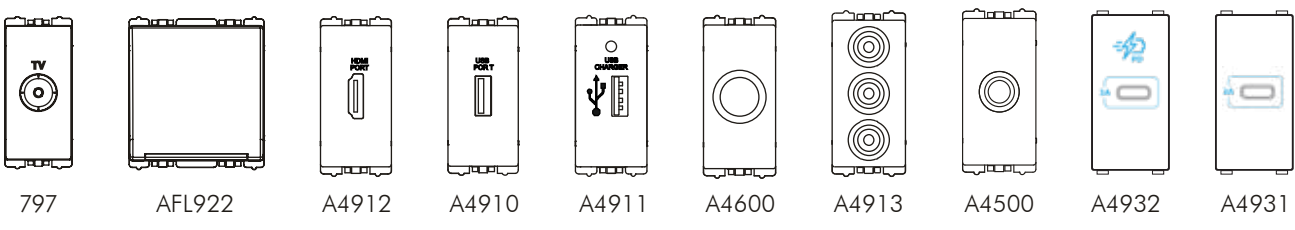
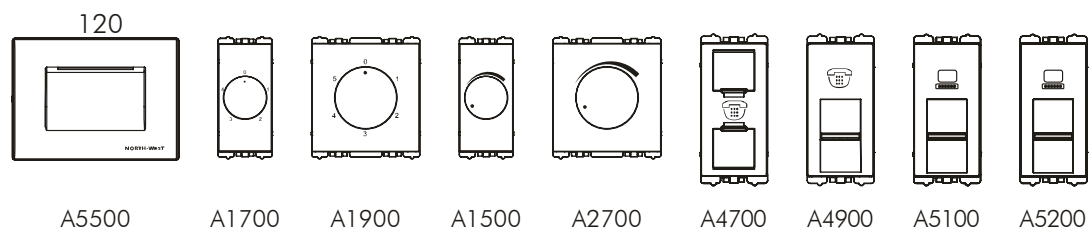
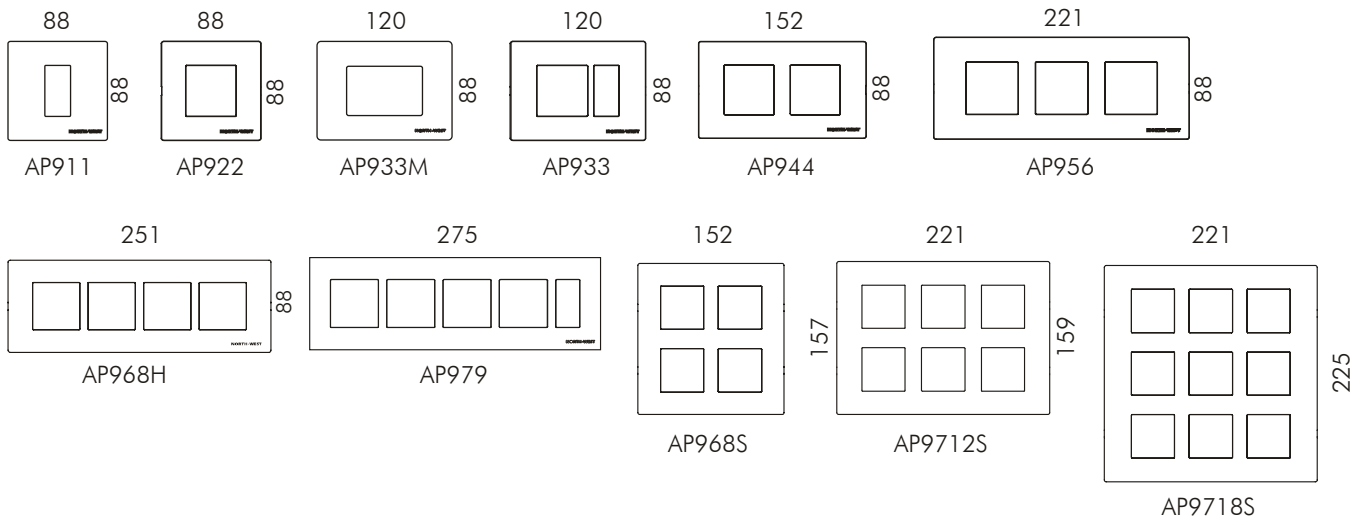
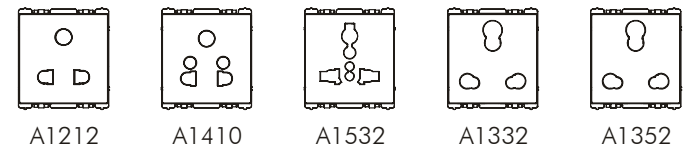
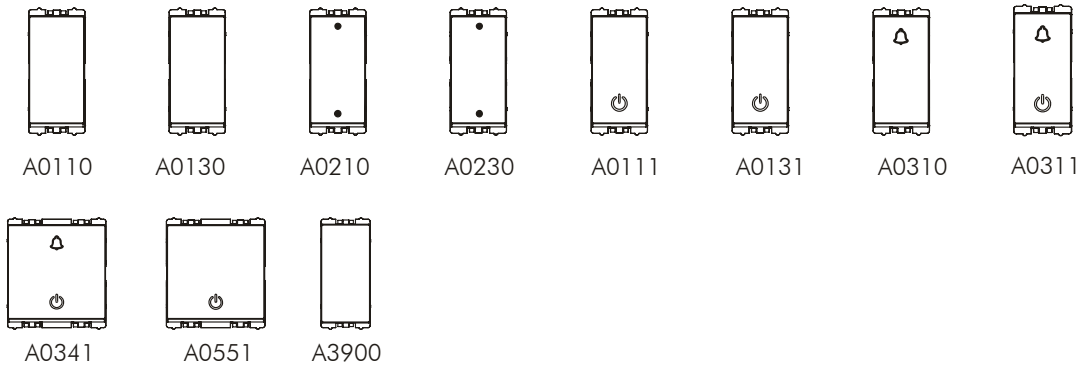

\*Wipro North-West presents anti-bacterial range in Nowa switches which provide protection against infection from bacteria and cross contamination.  
\*Nowa anti bacterial range is available on request only



Cat No	Module Size	Material Description	White MRP	Silver Grey/ Matt Black MRP	Inner/Outer Case/Lot
<b>SWITCHES</b>					
A0110	1M	Switch 6A one way	140	190	20/600
A0111	1M	Switch 6A one way with indicator	230	295	20/600
A0210	1M	Switch 6A two way	220	275	20/600
A0120	1M	Switch 10A one way	155	220	20/600
A0121	1M	Switch 10A one way with indicator	245	345	20/600
A0130	1M	Switch 16A one way	235	300	20/600
A0131	1M	Switch 16A one way with indicator	295	385	20/600
A0230	1M	Switch 16A two way	310	385	20/600
A0160	1M	Switch 20A one way	245	335	20/600
A0161	1M	20A One Way Switch with Indicator	315	430	20/600
A0150	1M	Switch 25A one way	365	490	20/600
A0151	1M	Switch 25A one way with indicator	465	625	20/600
A0551	2M	Switch 32A one way with indicator - DP 2M	685	870	10/300
A0310	1M	Bell Push 6A	230	285	20/600
A0311	1M	Bell Push 6A with indicator	370	490	20/600
A0341	2M	Bell Push 6A with indicator - Palm 2M	420	565	10/300
A0110 CMR/DND	1M	CMR/DND Switch 6A one way	150	150	20/600
A0210 DND	1M	DND Switch 6A two way	225	285	20/600
<b>SOCKETS</b>					
A1212	2M	Socket 6A 3 Pin with Round Pin	255	340	10/300
A1410	2M	Socket 6A 2/3 Pin	315	410	10/300
A1420	2M	Socket 10A 2/3 Pin	315	410	10/300
A1332	2M	Socket 6/16A 3 Pin - Power	410	525	10/300
A1532	2M	Socket 6/13A - International	395	495	10/300
A1342	2M	Socket 6/20A 3 pin - Power	465	575	10/300
A1352	2M	6/16A 6 Pin Heavy Duty - Power	465	575	10/300
<b>COVER PLATES</b>					
AP911	1M	1M Plate with frame	150	265	10/360
AP922	2M	2M Plate with frame	150	265	10/360
AP933	3M	3M Plate with frame	195	335	10/240
AP933M	3M	3M Plate with frame W/o Rib	195	335	10/240
AP944	4M	4M Plate with frame	225	365	8/192
AP956	6M	6M Plate with frame	280	455	5/120
AP968H	8M	8MH Plate with frame (Horizontal)	355	570	5/120
AP968S	8M	8MS Plate with frame (Square)	365	595	5/95
AP979	9M	9M Plate with frame	465	705	5/60
AP9712S	12M	12M Plate with frame	505	805	5/30
AP9718S	18M	18M Plate with frame	765	1195	5/20
<b>FAN REGULATORS AND DIMMERS</b>					
A1700	1M	Fan Reg. 4+1 Position Step Type 360 degree 1M	665	840	10/300
A1900	2M	Fan Reg. 5+1 Position Step Type 360 degree 2M	880	1125	6/120
A1500	1M	Dimmer 400W 1M	810	1035	10/300
A2700	2M	Dimmer 1000W 2M	1205	1575	6/120

Cat No	Module Size	Material Description	White MRP	Silver Grey/ Matt Black MRP	Inner/Outer Case/Lot
<b>COMMUNICATION MODULES</b>					
A4900	1M	Telephone Socket with single shutter - RJ11	205	285	20/600
A4700	1M	Telephone Socket with double shutter - RJ11	315	415	20/600
A5100	1M	Computer Socket with shutter - RJ45 Cat 5	535	670	20/600
A5200	1M	Computer Socket with shutter - RJ45 Cat 6	720	895	20/600
A4797	1M	Co-Axial TV Socket 1 Point	210	270	20/600
A4910	1M	USB Port	1205	1460	5/100
A4911	1M	1A USB Charger	1095	1255	5/100
A4921	1M	2A USB Charger	1285	1625	5/100
A4912	1M	HDMI Port	1400	1820	5/100
A4913	1M	RCA Socket	2570	3215	5/100
A4931	1M	3A USB Type C Charger	2910	3430	5/100
A4932	1M	3A Type C Fast Charger	4220	4975	5/100
AFL922	2M	LED Night Lamp (Foot Light)	975	1250	6/120
<b>SUPPORT MODULES</b>					
A5500	3M	Electronic Key Tag - 20A	4020	5400	1/20
A3900	1M	Blanking Plate	55	100	40/1200
A4500	1M	Cord Outlet	195	255	20/600
A4600	1M	Indicator Lamp - LED	250	315	20/300
A4603	1M	DND and CMR Combination	340	415	20/400
A4401	2M	Buzzer	405	525	8/160
A4400	1M	RJ45 Receptacle	120	305	20/600
<b>TINY TRIP AND MOTOR STARTER</b>					
6A - 32A Single Pole Tiny Trip			420	495	10/80
6A - 32A Double Pole Tiny Trip			895	1040	4/32
20A , 25A Motor Starter Single Phase			965	1125	4/32

# venia

THE SLEEK PERFORMER

Sleek switch  
Satin finish  
Sturdy design





## DIFFERENT SPACES, DIFFERENT NEEDS, EXPANSIVE RANGE

Venia offers a expansive range of products to cater to different spaces. With USPs of sleek design, premium finish yet affordability the Venia range of switches have analysed all the common user requirements and translated them as distinctive features to offer more benefits and added value to its users.

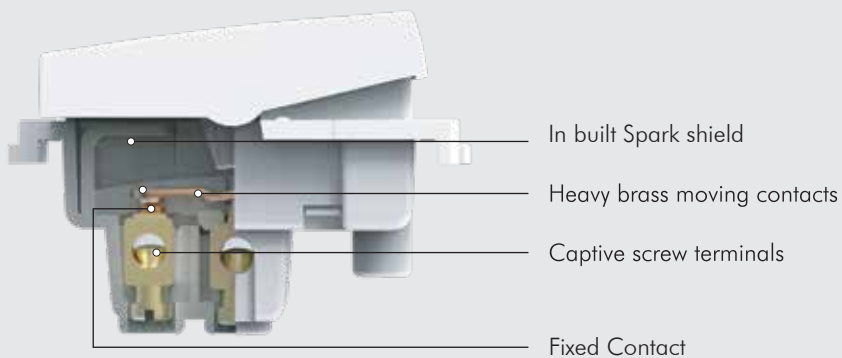
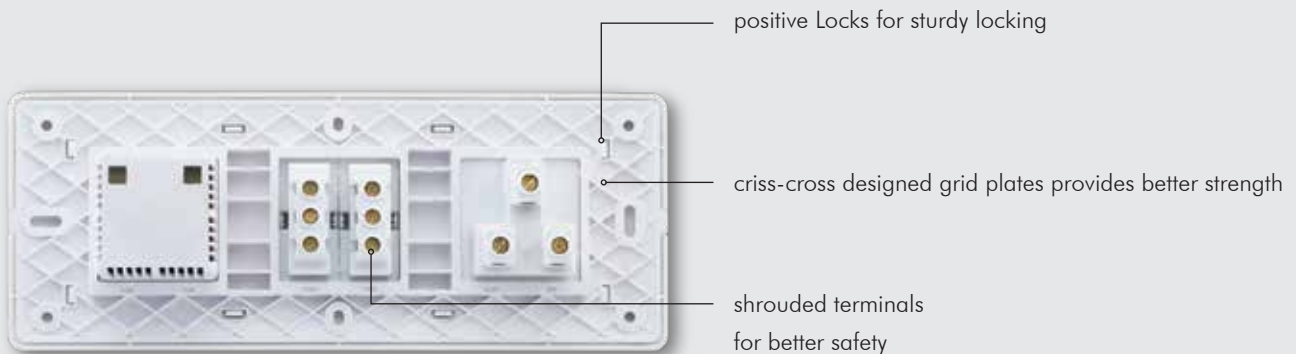
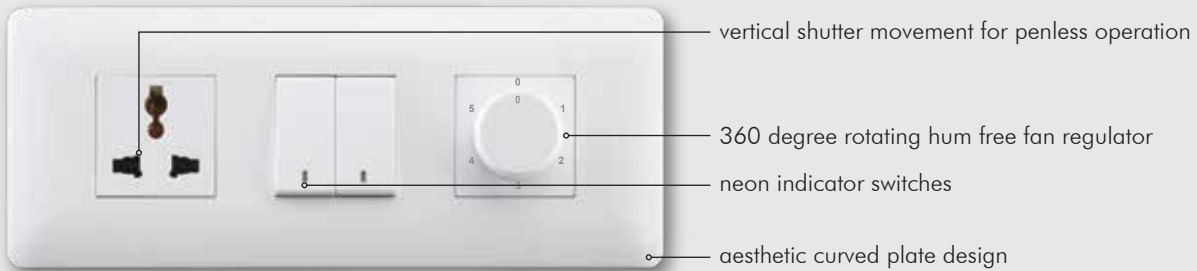

# venia

THE SLEEK PERFORMER

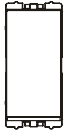

6A/16A  
1 way  
1M switch



6A/16A 1 way  
1M switch  
with indicator



6A 2 Way  
1M Switch



6A Bell Push  
1M Switch

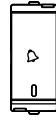

6A Bell Push  
1M Switch  
With Indicator

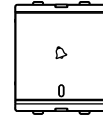

6A Bell Push  
2M Switch

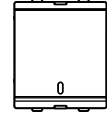

32A D.P 2M Switch

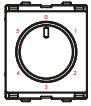

5 Step FR 2M

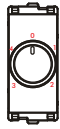

4 Step FR 1M



RJ 11 Socket



RJ 45 Socket



TV Socket

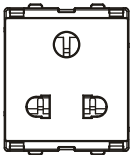

3 Pin Uni-D Socket

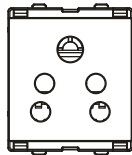

5 Pin Socket 2M

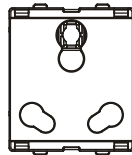

6/16A Socket 2M

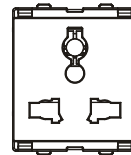

13A Universal Socket 2M

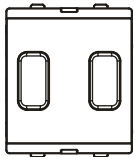

Motor Starter



Tiny Trip 1M

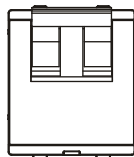

Tiny Trip 2M

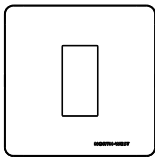

1M Plate

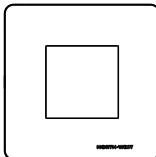

2M Plate

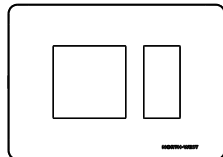

3M Plate

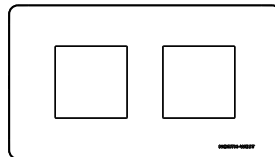

4M Plate

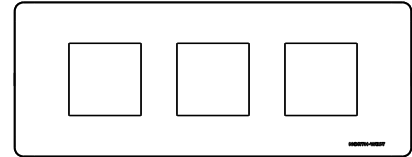

6M Plate

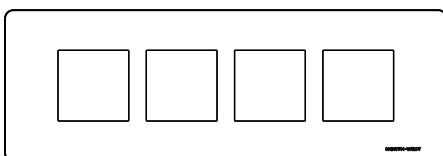

8M Plate

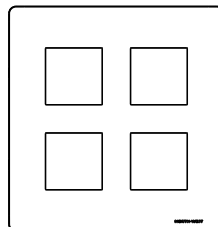

8MS Plate

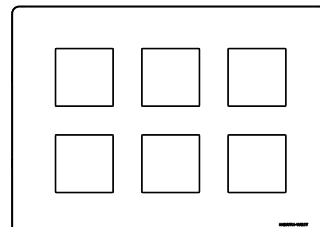

12M Plate

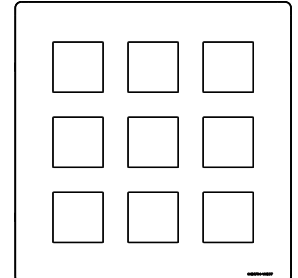

18M Plate





	<b>Cat No</b>	<b>Module Size</b>	<b>Material Description</b>	<b>White MRP</b>	<b>Dark Grey MRP</b>	<b>Inner/Outer Case Lot</b>
<b>SWITCHES</b>	B0110	1M	Switch 6A One Way	125	150	20/600
	B0120	1M	Switch 10A One Way	125	150	20/600
	B0111	1M	Switch 6A One Way with Indicator	200	245	20/600
	B0210	1M	Switch 6A Two Way	190	235	20/600
	B0220	1M	10A 2-way	195	240	20/600
	B0130	1M	Switch 16A One Way	205	250	20/600
	B0230	1M	16A Two Way Switch without Indicator	255	305	20/600
	B0131	1M	Switch 16A One Way with Indicator	260	310	20/600
	B0160	1M	Switch 20A one way	205	250	20/600
	B0161	1M	Switch 20A one way with indicator	260	310	20/600
	B0150	1M	Switch 25A one way	240	285	20/600
	B0151	1M	Switch 25A one way with indicator	305	370	20/600
	B0551	2M	Switch 32A One Way with Indicator - DP	575	690	10/600
	B0310	1M	Bell Push 6A	195	240	20/600
	B0311	1M	Bell Push 6A with Indicator	270	330	20/600
	B0341	2M	Bell Push 6A with Indicator - Palm	310	375	10/600
<b>SOCKETS</b>	B1212	2M	Socket 6A 3 - Pin With Round Pin	205	245	10/300
	B1220	2M	10A 3Pin Socket round pins	210	255	10/300
	B1410	2M	Socket 6A 2/3 Pin	250	300	10/300
	B1420	2M	10A 5 Pin Socket round pins	250	300	10/300
	B1332	2M	Socket 6/16A 3 Pin - Power	325	390	10/300
	B1342	2M	20A 3-pin Power Socket	330	470	10/300
	B1352	2M	6/16A 6 Pin Heavy Duty - Power	390	470	10/300
	B1532	2M	Socket 6/13A - International	335	400	10/300
<b>FAN REGULATORS</b>	B1700	1M	Fan Regulator 4+1 Position Step Type 360°	575	690	10/300
	B1900	2M	Fan Regulator 5+1 Position Step Type 360°	695	835	6/180
<b>COMMUNICATION AND SUPPORT MODULES</b>	B4900	1M	Telephone Socket with Single Shutter RJ11	180	220	20/600
	B4797	1M	Co-Axial Tv Socket 1 Point	185	225	20/600
	B5100	1M	Computer Socket with Shutter -RJ45 Cat 5	455	550	20/600
	B5200	1M	Computer Socket with Shutter -RJ45 Cat 6	665	800	20/600
	B4600	1M	Venia Indicator Lamp	185	225	20/600
	B4911	1M	1A USB Charger	915	1100	5/100
	B4921	1M	2A USB Charger	1105	1325	5/100
	B4500	1M	Cord Outlet	155	185	20/600
	B3900	1M	Blanking Plate	50	60	30/900
<b>COVER PLATES</b>	BBP911	1M	1M Plate With Frame	125	150	15/360
	BP922	2M	2M Plate With Frame	125	150	15/360
	BP933	3M	3M Plate With Frame (Rib)	155	185	10/240
	BP944	4M	4M Plate with frame	195	240	8/192
	BP956	6M	6M Plate With Frame	265	315	5/120
	BP968H	8M	8MH Plate With Frame (Horizontal)	305	370	5/120
	BP968S	8M	8MS Plate With Frame (Square)	325	390	5/95
	BP9712S	12M	12M Plate With Frame	450	540	5/95
	BP9716S	16M	16M Plate with Frame	620	750	5/40
	BP9718S	18M	18M Plate With Frame	675	810	5/40
<b>TT &amp; MS</b>	6A - 32A Single Pole Tiny Trip			395	475	10/80
	6A - 32A Double Pole Tiny Trip			890	1070	4/32
	20A , 25A Motor Starter Single Phase			1090	1310	4/32

## MOUNTING BOXES

Metal Box Type	Raw Material	Length (mm)	Width (mm)	Depth* (mm)	CD (mm)
1&2 Module	GI - Zinc Coated 120GSM	76	75	50	62
3 Module	GI - Zinc Coated 120GSM	100.5	75	50	86
4 Module	GI - Zinc Coated 120GSM	133	75	50	120
6 Module	GI - Zinc Coated 120GSM	207.5	75	50	196
8 Module H	GI - Zinc Coated 120GSM	230	75	50	216
8 Module S	GI - Zinc Coated 120GSM	136	140	50	120
12 Module	GI - Zinc Coated 120GSM	212	140	60	196
16 Module	GI - Zinc Coated 120GSM	230	140	60	160
18 Module	GI - Zinc Coated 120GSM	212	210	60	196

\*standard range

Cat No	Material Description	MRP (₹)	Inner Case Lot (Nos.)
<b>0.8mm METAL BOX</b>			
NW-MB01M22GGI	1-2M Metal Box GI 22G	113	80
NW-MB03M22GGI	3M Metal Box GI 22G	135	60
NW-MB04M22GGI	4M Metal Box GI 22G	155	50
NW-MB06M22GGI	6M Metal Box GI 22G	228	50
NW-MB8MS22GGI	8MS Metal Box GI 22G	258	30
NW-MB8MH22GGI	8MH Metal Box GI 22G	258	30
NW-MB12M22GGI	12M Metal Box GI 22G	367	20
NW-MB16M22GGI	16M Metal Box GI 22G	429	20
NW-MB18M22GGI	18M Metal Box GI 22G	485	20
NW-MB8MHU22GGI	8MH Metal Box GI 22G	300	30
NW-MB09MH22GGI	9MH Metal Box GI 22G	307	30

<b>1.0mm METAL BOX</b>			
NW-MB01M20GGI	1-2M Metal Box GI 20G	128	80
NW-MB03M20GGI	3M Metal Box GI 20G	151	60
NW-MB04M20GGI	4M Metal Box GI 20G	197	50
NW-MB06M20GGI	6M Metal Box GI 20G	266	50
NW-MB8MS20GGI	8M S Metal Box GI 20G	301	30
NW-MB8MH20GGI	8M H Metal Box GI 20G	301	30
NW-MB12M20GGI	12M Metal Box GI 20G	428	20
NW-MB16M20GGI	16M Metal Box GI 20G	500	20
NW-MB18M20GGI	18M Metal Box GI 20G	566	20
NW-MB8MHU20GGI	Universal 8MH Metal Box	330	30
NW-MB09MH20GGI	9MH Switch Plate	359	30

<b>1.2mm METAL BOX</b>			
NW-MB01M18GGI	18SWG-GI Flush Box for 1/2M Switch Plate	151	80
NW-MB03M18GGI	18SWG-GI Flush Box for 3M Switch Plate	185	60
NW-MB04M18GGI	18SWG-GI Flush Box for 4M Switch Plate	234	50
NW-MB06M18GGI	18SWG-GI Flush Box for 6M Switch Plate	326	50
NW-MB8MS18GGI	18SWG-GI Flush Box for 8MS Switch Plate	364	30
NW-MB8MH18GGI	18SWG-GI Flush Box for 8MH Switch Plate	364	30
NW-MB8MHU18GGI	18SWG-GI Universal 8MH Metal Box	400	20
NW-MB12M18GGI	18SWG-GI Flush Box for 12M Switch Plate	476	30
NW-MB18M18GGI	18SWG-GI Flush Box for 18M Switch Plate	662	20



Cat No	Material Description	MRP (₹)	Inner Case Lot (Nos.)
<b>1.0mm FOLDED TYPE BOXES</b>			
MB01M20GGIFT	20SWG-GI Flush Box 1/2M Plate Folded Type	128	40
MB03M20GGIFT	20SWG-GI Flush Box 3M Plate Folded Type	151	40
MB04M20GGIFT	20SWG-GI Flush Box 4M Plate Folded Type	197	40
MB06M20GGIFT	20SWG-GI Flush Box 6M Plate Folded Type	266	24
MB8MS20GGIFT	20SWG-GI Flush Box 8MS Plate Folded Type	301	20
MB8MH20GGIFT	20SWG-GI Flush Box 8MH Plate Folded Type	330	25
MB12M20GGIFT	20SWG-GI Flush Box 12M Plate Folded Type	428	12
MB16M20GGIFT	20SWG-GI Flush Box 16M Plate Folded Type	500	12
MB18M20GGIFT	20SWG-GI Flush Box 18M Plate Folded Type	566	12
<b>1.2mm METAL BOX</b>			
MB01M18GGI	18SWG-GI Flush Box for 1/2M Switch Plate	151	80
MB03M18GGI	18SWG-GI Flush Box for 3M Switch Plate	185	60
MB04M18GGI	18SWG-GI Flush Box for 4M Switch Plate	234	50
MB06M18GGI	18SWG-GI Flush Box for 6M Switch Plate	326	50
MB8MS18GGI	18SWG-GI Flush Box for 8MS Switch Plate	364	30
MB8MH18GGI	18SWG-GI Flush Box for 8MH Switch Plate	364	30
MB12M18GGI	18SWG-GI Flush Box for 12M Switch Plate	476	30
MB18M18GGI	18SWG-GI Flush Box for 18M Switch Plate	662	20
MB8MHU18GGI	18SWG-GI Universal 8MH Metal Box	400	20
<b>1.6mm METAL BOX</b>			
MB01M16GGI	16SWG-GI Flush Box for 1/2M Switch Plate	223	80
MB03M16GGI	16SWG-GI Flush Box for 3M Switch Plate	272	60
MB04M16GGI	16SWG-GI Flush Box for 4M Switch Plate	310	50
MB06M16GGI	16SWG-GI Flush Box for 6M Switch Plate	410	50
MB8MH16GGI	16SWG-GI Flush Box for 8MH Switch Plate	435	30
MB8MS16GGI	16SWG-GI Flush Box for 8MS Switch Plate	435	30
MB12M16GGI	16SWG-GI Flush Box for 12M Switch Plate	593	20
<b>1.0mm 40mm SHALLOW DEPTH</b>			
MB01M20GGI40MM	20SWG-GI Flush Box for 1/2M Plate 40MM	114	80
MB03M20GGI40MM	20SWG-GI Flush Box for 3M Plate 40MM	134	60
MB04M20GGI40MM	20SWG-GI Flush Box for 4M Plate 40MM	178	50
MB06M20GGI40MM	20SWG-GI Flush Box for 6M Plate 40MM	240	50
MB8MS20GGI40MM	20SWG-GI Flush Box for 8MS Plate 40MM	271	30
MB8MH20GGI40MM	20SWG-GI Flush Box for 8MH Plate 40MM	271	30
MB12M20GGI40MM	20SWG-GI Flush Box for 12M Plate 40MM	386	20
MB16M20GGI40MM	20SWG-GI Flush Box for 16M Plate 40MM	450	20
MB18M20GGI40MM	20SWG-GI Flush Box for 18M Plate 40MM	510	20
MB8MHU20GGI40MM	20SWG-GI Universal 8MH Metal Box 40MM	298	30
MB09MH20GGI40MM	20SWG-GI Flush Box for 9MH Plate 40MM	323	30
<b>1.2mm 40mm SHALLOW DEPTH</b>			
MB01M18GGI40MM	18SWG-GI Flush Box for 1/2M Plate 40MM	135	80
MB03M18GGI40MM	18SWG-GI Flush Box for 3M Plate 40MM	166	60
MB04M18GGI40MM	18SWG-GI Flush Box for 4M Plate 40MM	210	50
MB06M18GGI40MM	18SWG-GI Flush Box for 6M Plate 40MM	296	50
MB8MS18GGI40MM	18SWG-GI Flush Box for 8MS Plate 40MM	331	30
MB8MH18GGI40MM	18SWG-GI Flush Box for 8MH Plate 40MM	331	30
MB12M18GGI40MM	18SWG-GI Flush Box for 12M Plate 40MM	429	20
MB18M18GGI40MM	18SWG-GI Flush Box for 18M Plate 40MM	597	20
MB8MHU18GGI40MM	18SWG-GI Universal 8MH Metal Box 40MM	423	30

Cat No	Material Description	MRP (₹)	Inner Case Lot (Nos.)
<b>1.0mm 45mm</b>			
MB01M20GGI45MM	20SWG-GI Flush Box for 1/2M Switch Plate 45MM	121	80
MB03M20GGI45MM	20SWG-GI Flush Box for 3M Switch Plate 45MM	143	60
MB04M20GGI45MM	20SWG-GI Flush Box for 4M Switch Plate 45MM	187	50
MB06M20GGI45MM	20SWG-GI Flush Box for 6M Switch Plate 45MM	254	50
MB8MS20GGI45MM	20SWG-GI Flush Box for 8MS Switch Plate 45MM	286	30
MB8MH20GGI45MM	20SWG-GI Flush Box for 8MH Switch Plate 45MM	286	30
MB12M20GGI45MM	20SWG-GI Flush Box for 12M Switch Plate 45MM	407	20
MB16M20GGI45MM	20SWG-GI Flush Box for 16M Switch Plate 45MM	476	20
MB18M20GGI45MM	20SWG-GI Flush Box for 18M Switch Plate 45MM	539	20
MB8MHU20GGI45MM	20SWG-GI Universal 8MH Metal Box 45MM	314	30
MB09MH20GGI45MM	20SWG-GI Flush Box for 9MH Switch Plate 45MM	341	30
<b>1.2mm 60mm</b>			
MB01M18GGI60MM	18SWG-GI Flush Box for 1/2M Plate 60MM	180	70
MB03M18GGI60MM	18SWG-GI Flush Box for 3M Plate 60MM	220	48
MB04M18GGI60MM	18SWG-GI Flush Box for 4M Plate 60MM	277	40
MB06M18GGI60MM	18SWG-GI Flush Box for 6M Plate 60MM	390	40
MB8MS18GGI60MM	18SWG-GI Flush Box for 8MS Plate 60MM	438	24
MB8MH18GGI60MM	18SWG-GI Flush Box for 8MH Plate 60MM	438	24
<b>1.6mm 60mm</b>			
MB01M16GGI60MM	16SWG-GI Flush Box for 1/2M Plate 60MM	233	70
MB03M16GGI60MM	16SWG-GI Flush Box for 3M Plate 60MM	285	48
MB04M16GGI60MM	16SWG-GI Flush Box for 4M Plate 60MM	325	40
MB06M16GGI60MM	16SWG-GI Flush Box for 6M Plate 60MM	429	40
MB8MH16GGI60MM	16SWG-GI Flush Box for 8MH Plate 60MM	455	24
MB8MS16GGI60MM	16SWG-GI Flush Box for 8MS Plate 60MM	455	24
<b>MOLDED SURFACE BOXES</b>			
NW-RASM02M	Molded Surface Box for 1/2M Plate	99	60
NW-RASM03M	Molded Surface Box for 3M Plate	116	45
NW-RASM04M	Molded Surface Box for 4M Plate	128	30
NW-RASM06M	Molded Surface Box for 6M Plate	180	20
NW-RASM08MH	Molded Surface Box for 8MH Plate	226	20
NW-RASM08MHC	Molded Surface Box for M&SR 8MH Plate	226	20
NW-RASM08MS	Molded Surface Box for 8MS Plate	217	15
NW-RASM12M	Molded Surface Box for 12M Plate	287	10
NW-RASM18M	Molded Surface Box for 18M Plate	409	5
<b>MOLDED CONCEALED BOXES</b>			
NW-PCB01M	Molded Flush Box for 1/2M Switch Plate	158	60
NW-PCB03M	Molded Flush Box for 3M Switch Plate	194	45
NW-PCB04M	Molded Flush Box for 4M Switch Plate	256	30
NW-PCB06M	Molded Flush Box for 6M Switch Plate	357	20
NW-PCB8MS	Molded Flush Box for 8MS Switch Plate	450	15
NW-PCB8MH	Molded Flush Box for 8MH Switch Plate	450	20
NW-PCB12M	Molded Flush Box for 12M Switch Plate	589	10

Cat No	Material Description	MRP (₹)	Inner Case Lot (Nos.)
<b>PLASTIC ENCLOSURES</b>			
NW-SM10000000	One Module Plastic Box with cover	213	1
NW-SM20000000	Two Module Plastic Box with cover	213	1
NW-SM30000000	Three Module Box with cover	238	1
NW-SM40000000	Four Module Box with cover	276	1
NW-SM60000000	Six Module Box with cover	363	1

## PLUG TOP

Cat No	Material Description	MRP (₹)	Inner Case Lot (Nos.)
P9111	6A 3-Pin Plug Top	120	12
P9131	16A 3-Pin Plug Top	170	10
P9151	16A Heavy Duty 3-Pin Plug Top	210	10



Metal Box



Plastic Enclosure



Plug Top

## SAFETY DEVICES

### FIANZA

MINIATURE CIRCUIT BREAKER

#### MCB

Rating (Amp)	SP (₹)	SPN (₹)	DP (₹)	C-curve TP (₹)	TPN (₹)	FP (₹)
6A, 10A, 16A, 20A 25A, 32A	240	780	800	1330	1760	1780
40A	570	1260	1260	1970	2420	2540
63A	640	1330	1330	2035	2490	2610

Case lot for SP 48 nos. DP 24 nos. TP 16 nos. TPN & FP 12 nos.

#### LOAD BREAK SWITCHES (ISOLATORS)

Rating (Amp)	DP MRP (₹)	FP MRP (₹)
40A	460	1050
63A	620	1170

#### RC TRIP (RESIDUAL CURRENT CIRCUIT BREAKER - RCCB)

Rating (Amp)	30mA		100mA		300mA	
	DP (₹)	FP (₹)	DP (₹)	FP (₹)	DP (₹)	FP (₹)
16A	1,910	2,400	1,855	2,300	1,855	2,300
25A	1,910	2,400	1,855	2,300	1,855	2,300
32A	2,025	2,480	1,995	2,395	1,995	2,395
40A	2,025	2,480	1,995	2,395	1,995	2,395
63A	2,675	2,825	2,525	2,765	2,525	2765

#### POWER UNITS

Cat No	Description	Standard of Rating	MRP (₹)	Inner Case Lot (Nos.)
ACPU6M-FT	6M Flush type with Starter, DP MCB & Plug top with Indicator	G/H/J	1,325	24
ACPU4M-FT	4M Flush type with Starter & Plug top with Indicator	G/H/J	925	40
ACPU6M-BT	6M Surface mounted with Starter DP MCB & Plug top with Indicator	G/H/J	1,450	24
ACPU4M-BT	4M Surface mounted with Starter & Plug top with Indicator	G/H/J	980	32

#### HEAVY DUTY PLUG & SOCKET UNIT (WITH MCB)

PU3M-FT	3M Flush Type with SP MCB & Plug top with Indicator	675	72
PU3M-BT	3M Surface mounted with SP MCB & Plug Top with Indicator	720	40



Power Unit

MCB

RCCB



## SAFETY DEVICES



- Manufactured as per IEC61439-3 standards, IP & IK tested by CPRI
- Contemporary flat design with less than 15mm projection from wall\*
- RAL 9003 matte finish Signal white color
- Curved corners for premium aesthetics and electrician safety
- High grade CRCA & powder coating, tested as per ASTM B117 standards
- Provision for surface & flush mounting
- Complete range for domestic requirements



Tested By CPRI\*

IP43\*

IK09\*

\*For double-door variants

Non-standard items will be delivered 4 - 8 weeks from date of PO





Mat Code	Material Description	MRP (₹)
NW-AV04WSPNSD	Avancee - 4 Way SPN SD	1560
NW-AV06WSPNSD	Avancee - 6 Way SPN SD	1720
NW-AV08WSPNSD	Avancee - 8 Way SPN SD	1980
NW-AV12WSPNSD	Avancee - 12 Way SPN SD	2460
NW-AV16WSPNSD	Avancee - 16 Way SPN SD	2720
NW-AV04WSPNDD	Avancee - 4 Way SPN DD	2050
NW-AV06WSPNDD	Avancee - 6 Way SPN DD	2280
NW-AV08WSPNDD	Avancee - 8 Way SPN DD	2610
NW-AV12WSPNDD	Avancee - 12 Way SPN DD	3150
NW-AV16WSPNDD	Avancee - 16 Way SPN DD	3770
NW-AV04WTPNSD	Avancee - 4 Way TPN SD (8+12)	4570
NW-AV06WTPNSD	Avancee - 6 Way TPN SD (8+18)	5530
NW-AV08WTPNSD	Avancee - 8 Way TPN SD (8+24)	6730
NW-AV12WTPNSD	Avancee - 12 Way TPN SD (8+36)	10140
NW-AV04WTPNDDECO	Avancee - 4 Way TPN DD (4+12)	4900
NW-AV04WTPNDD	Avancee - 4 Way TPN DD (8+12)	5220
NW-AV06WTPNDD	Avancee - 6 Way TPN DD (8+18)	6440
NW-AV08WTPNDD	Avancee - 8 Way TPN DD (8+24)	7760
NW-AV12WTPNDD	Avancee - 12 Way TPN DD (8+36)	11540
NW-AV02WENC*	Avancee- 2 Way metal enclosure	870
NW-AV04WENC*	Avancee- 4 Way metal enclosure	870
NW-AV20ASPNS	Avancee - Metal Plug & Socket Outlets - 20A SPN	2300
NW-AV20ATPNP	Avancee - Metal Plug & Socket Outlets - 20A TPN	3740
NW-AV30ATPNP	Avancee - Metal Plug & Socket Outlets - 30A TPN	4650
NW-AV04WVTPNDD	Avancee - 4 Way Vertical TPN DD (8+12)	12730
NW-AV06WVTPNDD	Avancee - 6 Way Vertical TPN DD (8+18)	13280
NW-AV08WVTPNDD	Avancee - 8 Way Vertical TPN DD (8+24)	16300
NW-AV12WVTPNDD	Avancee - 12 Way Vertical TPN DD (8+36)	21760
NW-AV04WTPNPIDD	Avancee - 4 Way TPN PPI DD (8+6+6+6)	10180
NW-AV06WTPNPIDD	Avancee - 6 Way TPN PPI DD (8+8+8+8)	11150

\*Available in pack size of 10 units

Mat Code	Material Description	MRP (₹)
NW-AV08WTPNPPIDD	Avancee - 8 Way TPN PPI DD (8+10+10+10)	12580
NW-AV10WTPNPPIDD	Avancee - 10 Way TPN PPI DD (8+12+12+12)	17010
NW-AV04WPHSELDD63A	Avancee - 4 Way Phase Selector TPN DD (63A)	17810
NW-AV06WPHSELDD63A	Avancee - 6 Way Phase Selector TPN DD (63A)	18080
NW-AV08WPHSELDD63A	Avancee - 8 Way Phase Selector TPN DD (63A)	19520
NW-AV12WPHSELDD63A	Avancee - 12 Way Phase Selector TPN DD (63A)	21860
NW-AV04W8SEGPSDD	Avancee - 4 Way 8SEG DD (8+12+12)	16000
NW-AV06W8SEGPSDD	Avancee - 6 Way 8SEG DD (8+12+18)	17500
NW-AV08W8SEGPSDD	Avancee - 8 Way 8SEG DD (8+12+24)	19940
NW-AV12W8SEGPSDD	Avancee - 12 Way 8SEG DD (8+12+36)	24200
NW-AV4T28WTIERDD	Avancee - 28 Way Flexi Tier DB (7X4)	7870
NW-AV4T40WTIERDD	Avancee - 40 Way Flexi Tier DB (10X4)	8940
NW-AV4T48WTIERDD	Avancee - 48 Way Flexi Tier DB (12X4)	9830
NW-AV4T56WTIERDD	Avancee - 56 Way Flexi Tier DB (14X4)	10810
NW-AV04WECOTPNCEB	Avancee - CEB for 4 Way TPN DD (4+12)	1290
NW-AV04WTPNCEB	Avancee - CEB for 4 Way TPN DD (8+12)	1590
NW-AV06WTPNCEB	Avancee - CEB for 4 Way TPN DD (8+18)	1940
NW-AV08WTPNCEB	Avancee - CEB for 4 Way TPN DD (8+24)	3050
NW-AV12WTPNCEB	Avancee - CEB for 4 Way TPN DD (8+36)	3900
NW-AV06WVTIERPPIDD	Avancee - Vertical TPN PPI DD (8+6+18)	11030
NW-AV08WVTIERPPIDD	Avancee - Vertical TPN PPI DD (8+6+24)	15010
NW-AV10WVTIERPPIDD	Avancee - Vertical TPN PPI DD (8+6+30)	15900
NW-AV12WVTIERPPIDD	Avancee - Vertical TPN PPI DD (8+6+36)	17040
NW-AV08WSPNDDTVTEL	Avancee - 08 Way SPN DD TVTEL	4340
NW-AV12WSPNDDTVTEL	Avancee - 12 Way SPN DD TVTEL	5140
NW-AV16WSPNDDTVTEL	Avancee - 16 Way SPN DD TVTEL	5880
NW-AV04WTPNDDTVTEL	Avancee - 04 Way TPN DD TVTEL	8810
NW-AV06WTPNDDTVTEL	Avancee - 06 Way TPN DD TVTEL	9500
NW-AV08WTPNDDTVTEL	Avancee - 08 Way TPN DD TVTEL	10420

## OUR ESTEEMED CLIENTELE

### BANKS

- Axis Bank
- Bank of Baroda
- Bank of Punjab
- Citibank
- HDFC Bank
- Kotak Bank
- Punjab National Bank
- Reserve Bank of India
- Royal Bank of Scotland
- State Bank of Hyderabad
- State Bank of India
- State Bank of Patiala
- United bank of India

### EDUCATIONAL INSTITUTIONS

- Amity School, New Delhi
- Apeejay Engineering College, Sohna
- Cambridge School, Dehradun & Noida
- Delhi Public School, New Delhi
- Delhi University
- Euro School, Mumbai
- G D Goianka Group, Delhi, NCR
- Global Institute of Sciences, Amritsar
- Gurunanak Dev University, Amritsar
- Gyanjyoti Management College, Mohali
- IIIT Delhi Campus
- IIM Campus, Indore
- IIT, Delhi, Mandi
- IIM, Indore
- Indian Institute of Technology, Kanpur
- ITL Public School, New Delhi
- Lotus Valley International School, Noida
- Narsee Monji Institute of Management, Mumbai
- National Institute of Fashion Technology, New Delhi
- National Institute of Health and Family Welfare Constructio of International Hostel
- NIIT, New Delhi
- Rajeev Gandhi Law University, Punjab

- Universal High School, Mumbai
- Christ University, Bangalore
- KLE University, Belgaum
- SS Education Society, Belgaum
- Calcutta University Arts Library
- M.P.Birla Secondary High School- Kolkata
- Board of Practical Training
- IIIT- Guwahati
- IIT – Patna
- Brainware University, Barasat
- KL University, Vijayawada

### REALTY FIRMS

- ACME Buildcon, Mohali, Amritsar
- Ansal Group, Mumbai
- Ardee City Royal Villas, Gurgaon
- Aristo Realty, Mumbai
- Ashiana Group, Rajasthan
- CHD Developers, Delhi NCR
- DLF Limited
- Emaar MGF
- Equinox Realty, Mumbai
- ERA Constructions, NCR
- EROS Group, New Delhi
- Hiranandani, Mumbai
- IREO, New Delhi, NCR
- JLPL, Mohali
- K Raheja Corp, Mumbai
- K Raheja Universal, Mumbai
- Kamdhenu Builders – Panchkula, J&K
- Kanakia Group, Mumbai
- Lavasa Constructions
- Lokhandwala Constructions
- Mahindra Lifespaces, Mumbai
- Marathon Group, Mumbai
- Nahar Group, Mumbai
- Neelkanth Group, Mumbai
- Orchid Gardens, Gurgaon
- Pacifica Group, Ahmedabad
- Panchasheel Group, Delhi



- Parshwanath Developers, New Delhi
- Peninsula Group, Mumbai
- Pride Purple, Pune
- Purvanchal Group, Delhi
- Rahejas, Mumbai
- Rajeev Swagruha Housing, Andhra Pradesh
- Safal Group, Ahmedabad
- Siddhi Group, Thane
- Sumadhura Constructions, Bangalore
- Umang Realtech, NCR
- Unitech Limited
- Uniworld City, Gurgaon
- Vijayshree Group, Bangalore
- Vipul Limited
- Wadhwa Group, Mumbai
- Aditya Constructions, Hyderabad & Vishakhapatnam
- Shanta Sriram, Hyderabad
- AWHO, Chennai & Kochi
- Sri Venkateswara Constructions, Hospet
- Green Shapes Developers, Bangalore
- Adithi Constructions, Bangalore
- DNDL Constructions, Guntur
- DS & Jaks Constructions, Bangalore
- RDB Legend Infrastructure Pvt. Ltd., Hyderabad
- NCC Urban Infrastructure Ltd. Hyderabad
- Anubandhana Infratech Pvt. Ltd. Guntur
- Royal Shelters, Chennai
- Merlin Group, Kolkata
- Space Group, Kolkata
- Siddha Group, Kolkata
- Hiland Group Kolkata
- Rohara Group, Kolkata
- Arihant Group- Kolkata
- Saltee Group- Saltlake, Kolkata
- Om Skylark- Mahadeo Nirman, Kolkata
- Z1- BBSR, Orissa
- Z Estates Pvt. Ltd.- BBSR, Orissa
- Z Engineers - BBSR, Orissa
- Home Town – Jajpur, Orissa
- JVC Hallmark, Chennai

## GOVERNMENT INSTITUTIONS

- Advanced Cancer Diagnostic, Treatment and Research Centre – Punjab Institute of Medical Sciences Society
- Bridges & Roads Punjab
- Central Electrical Authority, New Delhi
- Central Public Works Department (CPWD)
- Chandigarh Housing Board
- Delhi Development Authority
- Delhi Metro Rail Corporation
- Department of Atomic Energy "Raja Ramanna Centre for Advanced Technology (RRCAT)"
- Department of Tele-communications,
- General Pull Office Building (GPO), New Delhi
- Housing and Urban Development (HUDCO)
- HUDA & GAMADA
- Indian Institute of Integrative medicine- construction of GLP standard invivo lab
- MES-Command Hospital
- Ministry of Health and family welfare- electrical works for all institute of Auyurveda
- National Institute of Malaria Research-Construction of Test Research Lab
- National Projects Construction Corporation
- National Thermal Power Corporation (NTPC), New Delhi
- NBCC, New Delhi
- NDMC, New Delhi
- Police Housing residential complex
- Power Finance Corporation, New Delhi
- Punjab Police Housing Corporation
- AWHO- Kolkata
- Geological Survey of India ( GSI)
- PWD West Bengal
- PWD Assam
- Eastern Railway
- Kolkata Metro Railway
- Board of Practical Training ( BOPT), Saltlake
- Airport Authority of India (AAI)
- Unique Identification Authority of India
- World Health Organization (WHO Building), New Delhi

## OUR ESTEEMED CLIENTELE

### HOTELS

- Grand Hyatt, Goa
- ITC Fortune Hotel, Gurgaon
- ITC Grand Maratha, Mumbai
- Kamath Group, Mumbai
- KFC
- Le Grande, Ahmedabad
- Le Meridian, Mumbai
- Maratha Sheraton, Mumbai
- MBD Group of Hotels
- Mountview Hotels, Chandigarh
- Orchid Group, Mumbai
- Raddisson, Delhi, Amritsar, Manesar
- Shangrila Hotels, Ahmedabad
- Sri Krishna Holiday Inn, Hyderabad
- Taj Group
- Taj Residency, Bangalore
- The Claridges Hotel, New Delhi
- The Hyatt, New Delhi
- The Oberoi Group, Mumbai, Kolkata
- Oberoi Grand- Kolkata
- Trident Hotel- BBSR
- Trident, Udaipur, Chennai

### IT & ITES

- Cadence Design System, Noida
- Caterpillar, Bangalore
- Computer Science Corporation, Noida
- GE - ITC, Bangalore
- GE Capital International Services – Bangalore, Hyderabad, Gurgaon
- I-Gate Global Solutions, Bangalore
- IMEC, Bangalore
- Infogain India Limited, Noida
- Infosys Technologies Ltd., Bangalore
- Jubilant Technologies, Noida
- Mcafee Software, Bangalore
- MICO Bosch, Bangalore

- Mitsubishi IT Services, Bangalore
- NIIT Ltd, New Delhi
- Nucleus Software Export, Noida
- Patni Computers, Noida
- R Systems, Noida
- Suvarna News
- Texas Instruments, Bangalore
- Vodafone, Bhubaneswar
- Wipro-GE Medical, Whitefield, Bangalore

### HOSPITALS

- AIIMS – New Delhi, Jodhpur, Bhopal
- BAPS, Gujarat
- Baptist Hospitals, Bangalore
- Batra Hospital (Heart Command), New Delhi
- Bedekar Hospital, Thane
- BIOCON Group, Bangalore
- Birla Hospital, Jaipur
- Bombay Heart Institute & Research Centre, Mumbai
- Breach Candy Hospital, Mumbai
- Escort Fortis – New Delhi, Jaipur, Mohali, Kangda
- ESIC Hospital – Hyderabad & Mangalore
- Eternal Hospital, Jaipur
- G.K. General Hospital – Kutch, Bhuj
- GE Medical Systems X-Ray Pvt. Ltd., Whitefield, Bangalore
- Hiranandani Hospital, Mumbai
- IVY Hospital – Mohali, Hoshiyarpur, Navshera
- Jaipur Golden Hospital, New Delhi
- JP Medical Hospital, Noida
- KIMS Hospital, Hyderabad & Bellary
- Kokilaben Ambani Hospital – Mumbai
- National Institute of Heart & Lungs, New Delhi
- PGI Medical Sciences, Chandigarh
- PIMS, Jalandhar
- Rajiv Gandhi Cancer Hospital, New Delhi
- Ravindranath GE Medical Associates, Hyderabad
- Rockland Hospital, New Delhi
- Saifee Hospital, Mumbai
- Shri Balaji Hospitals, Delhi
- Sir Ganga Ram Hospital, New Delhi
- Medica Hospital- Kolkata



- RIMS - Imphal
- Zenith Hospital, Belghoria, Kolkata
- Kolkata Medical College Superspeciality Hospital, Kolkata
- Sagar Dutta Medical College & Hospital, Kamarhati, Kolkata
- Bahampur Medical College, Murshidabad
- Vardhaman Medical College, New Delhi
- Wasan Hospitals, Mumbai

## **COMMERCIAL OFFICE SPACE**

- Cargill Foods, Bangalore
- Time Inc, Bangalore
- Arvind Mills, Bangalore
- Capgemini, Bangalore
- Citizen Industries, Bangalore
- Britannia, Bangalore
- Abbott Healthcare, Bangalore
- AWFIS- Saltlake
- Tata Motors- Jamshedpur
- Odisha Diploma Engineers Service
- Association- BBSR, Orissa
- Hexaware Technologies, Chennai

## **PHARMA/ INDUSTRIAL**

- Kewaunee Scientific Corporation, Bangalore
- Hetero Drugs, Hyderabad & Visakhapatnam
- Hetro Health Care - Guwahati
- Shell, Bangalore
- Gland Pharma Limited, Hyderabad & Visakhapatnam
- Shanta Biotech, Hyderabad

## **WARRANTY**

The Company undertakes to replace or repair products at its discretion, should they become defective solely as a result of faulty material and or workmanship within 10 years in the case of electro-mechanical wiring products, such as unpainted/noncoated switches, sockets, plates, switches without indicators. 1.5 years in the case of mains related electronic wiring device products such as fan regulators, dimmers, switches with LED indicators Hospitality & communication modules including indicator Modules and one year in case of surface coated products like Distribution Boards, coated plates, metal plates & metal boxes. Also one year in case of protection/security devices like MCB, Tiny-Trip, Motor Starters RCCB, and VDPs. The guarantee will be invalidated if the product has not been installed or maintained in accordance with the Company's instructions, or if any attempt has been made to rectify, dismantle or alter the product or if the products are not accompanied with purchase bill/s or warranty card. The guarantee states the Company's entire liability. It does not extend to cover consequential loss or damage or installation costs arising from the defective product.



# NORTH-WEST

## WIPRO ENTERPRISES (P) LIMITED,

Registered Office: Plot No.8, Wipro House,  
80Ft Road, Koramangala,Bengaluru-560034, KA, India.

Write to: Wipro Consumer Care, Plot No.8,  
Wipro House, 80Ft Road, Koramangala,  
Bengaluru-560034, KA.

Call Toll free No. 1-800-425-1969  
Email us at : feedback.wcc@wipro.com

Visit us at : www.wipronorthwest.com

[facebook.com/WiproNorthWestSwitches](https://www.facebook.com/WiproNorthWestSwitches)

Product Category	HSN Code	GST
All Type of Switch including Key Tag, DND, MMR	85365020	18%
All Type of Socket, Shaver Socket, USB Data Transmission Socket, HDMI,VGA, RCA Socket	85366910	18%
Fan Regulator	84149030	18%
RJ 11, RJ 45, TV Socket	85366990	18%
Foot Lamp	94054090	18%
Indicator Lamp, DND and MMR outdoor Panel	85318000	18%
USB Charger	85044030	18%
Chime, Buzzer	85311090	18%
Motor Starter	85369010	18%
Mini MCB	85362030	18%
Plates, GI Box, Surface Box	85389000	18%
Plug Top, Fuse	85366910	18%
VDP	85171190	18%

## BRANCH ADDRESSES

### ANDHRA PRADESH

Wipro Enterprises (P) Ltd.,  
Door No : 1-99,  
Sirigudi Nagar, Yendada,  
Visakhapatnam- 530045  
Tel - 9676908080

### AURANGABAD

Wipro Enterprises (P) Ltd.,  
K-87, MIDC, Waluj, Gut No. 32,  
Plot No.3, Rajangaon (Senpunje),  
Taluka – Gangapur, Aurangabad- 431 136  
Tel : 0240 6003077 / 6002077

### BIHAR

Wipro Enterprises (P) Ltd.,  
Godown No 1, Didar Ganj Baazar  
Samiti Patna - 800001  
Tel : 0612-2640855

### CHATTISGARH

Wipro Enterprises (P) Ltd.,  
Ring Road, No.1, Near Jagdamba  
Mandir, Opp Manchanda Steel,  
Professor Colony, Raipur – 492 013  
Tel : 0771-3265725

### GUJARAT

Wipro Enterprises (P) Ltd.,  
Plot No. 610-612, Near Forest  
Quarters, Opp. Hotel Parichay,  
National Highway No- 08, Aslali,  
Ahmedabad – 382 427  
Tel : 02718-321819/9033021988

### HARYANA

Wipro Enterprises (P) Ltd.,  
185-186, Markendey Complex, Sena  
Nagar, Ambala City, Ambala – 134 002  
Tel : 0171-2522035

### BENGALURU

Wipro Enterprises Pvt Ltd,  
No.139, 3rd Cross N S Palya ,  
Off Bannerghata Road  
Bangalore – 560076  
Tel: 080-40541950

### KERALA

Wipro Enterprises (P) Ltd.,  
Vi/409D, Valom Kottil Building,  
Opp. Bharat Mata College,  
Sea Port - Airport Road,  
Thirikkakara Cochin – 682 021  
Tel : 0484-6555545/2421168

### MADHYA PRADESH

Wipro Enterprises (P) Ltd.,  
86/8/1, Lasudiya Mori,  
Near Shivani Transport, Devas  
Naka, Indore – 452 010  
Tel : 0731-3299668/3298765

### MUMBAI

Wipro Enterprises (P) Ltd.,  
203, 204, Hindustan Kohinoor,  
Industrial Estate, LBS Road,  
Vikroli - West, Mumbai – 400 083  
Tel : 022-67213757/67213755-63

### NAGPUR

Wipro Enterprises (P) Ltd.,  
191, Rachana Apartments,  
First Floor, Shivajinagar, Cement Road,  
Dharmapeth, Nagpur – 440 010  
Tel : 0712-2569878

### NEW DELHI

Wipro Enterprises (P) Ltd.,  
E – 40/7, Okhla Industrial Area, Phase-  
II, New Delhi – 110 020  
Tel : 011-41708122-29

### ORISSA

Wipro Enterprises (P) Ltd.,  
C/O Hindustan Agencies, Plot No 135,  
Mancheswar Ind. Estate, Rasulgarh  
Bhubaneswar - 751 010  
Tel : 067-46450804

### PUNE

Wipro Enterprises (P) Ltd.,  
1195/5, Fergusson College Road,  
Bhosale Heights, 3rd Floor,  
Pune – 411 005  
Tel : 020-25535081/25535401

### PUNJAB

Wipro Enterprises Pvt Ltd. Precto Pipes  
Compound, Dayalpur Road, Jungian, SAS  
Nagar, Punjab - 140603  
Tel : 0172-501834, 2660714

### RAJASTHAN

A-71, Road No 1, Vishwakarma  
Industrial Area , Jaipur -302013  
Tel : 0141-2280014

### TAMILNADU

Wipro Consumer Care and Lighting,  
Svalar Square, 15 NP Developed Plot,  
Guindy Industrial Estate, Ekkaduthangal,  
Chennai - 600032  
Tel : 044-24769653

### TELANGANA

Wipro Enterprises Pvt. Limited,  
G BLOCK,6th Floor, Surya Towers,105,  
Sardar Patel Road, Kalasiguda,  
Secunderabad Telangana-500003

### UTTRAKHAND

Wipro Enterprises (P) Ltd.,  
C/O Arihant Associates,(C&F Agent),  
HCL Compound, Niranjanpur,  
Dehradun – 248171  
Tel : 0135-2620912

### UTTAR PRADESH

Wipro Enterprises (P) Ltd.,  
E-149, Transport Nagar, Kanpur Road,  
Lucknow (UP) – 226 012  
Tel : 0522-2434352

### WEST BENGAL

Wipro Enterprises (P) Ltd.,  
3, Pretoria Street, 3rd Floor,  
Kolkata - 700 071  
Tel : 033-22829268/44045887



**ARTISA**  
*elegance redefined*

**ARTISA**  
— FLAT —  
*elegance redefined*

ARTISA and ARTISA Flat, a premium range of switches; simplicity with elegance redefined with exquisite finishes that add a touch of style to your interiors.



**NORTH · WEST**

**WIPRO ENTERPRISES (P) LTD.,**

Registered Office: Plot No.8, Wipro House, 80Ft Road, Koramangala, Bengaluru-560 034, KA, India.

For feedback/queries, contact executive:

Wipro Consumer Care, Bengaluru - 560 034, KA.

✉ [feedback.wcc@wipro.com](mailto:feedback.wcc@wipro.com) | [northwest.switches@wipro.com](mailto:northwest.switches@wipro.com)

☎ 1-800-425-1969

Visit us at: [www.wipronorthwest.com](http://www.wipronorthwest.com) | [facebook.com/WiproNorthWestSwitches](https://www.facebook.com/WiproNorthWestSwitches)